

DAIKIN

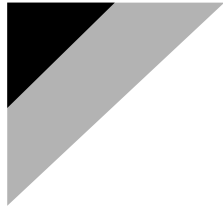

+

INSTALLATION MANUAL

VRV[®] III System air conditioner

English

Français

Español

+

RXYQ72PAYD
RXYQ96PAYD
RXYQ108PAYD
RXYQ144PAYD
RXYQ168PAYD
RXYQ192PAYD
RXYQ72PATJ
RXYQ96PATJ
RXYQ108PATJ
RXYQ144PATJ
RXYQ168PATJ
RXYQ192PATJ

+

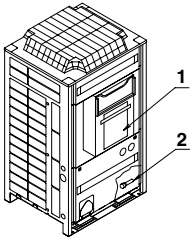

figure 1

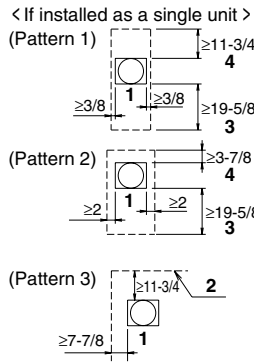

figure 2

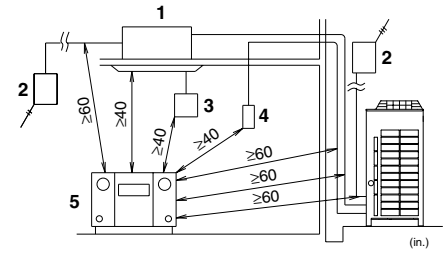
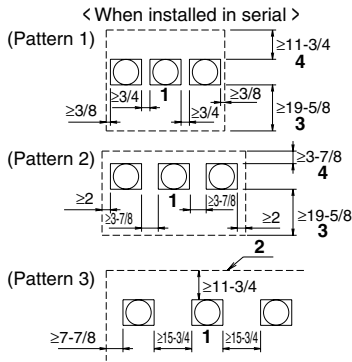

figure 3

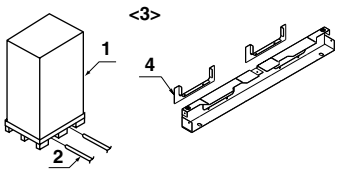

figure 4

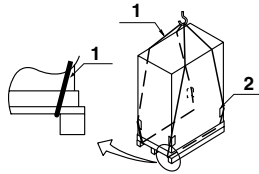

figure 5

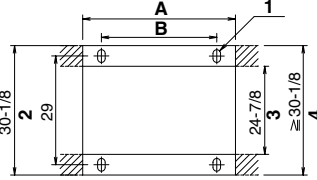

figure 7

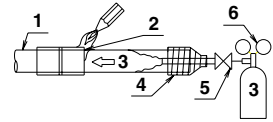

figure 8

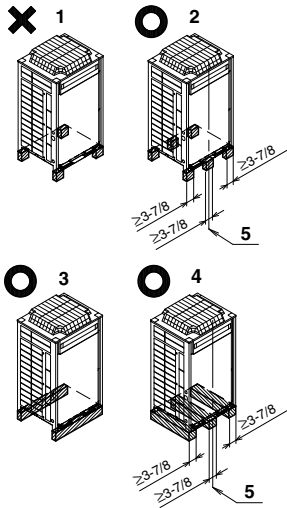

figure 6

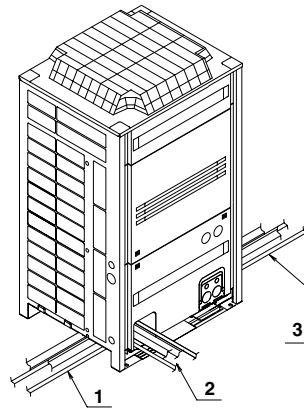

figure 9

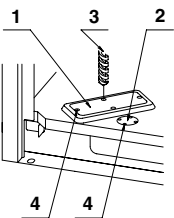

figure 10

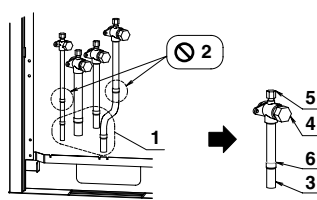

figure 11

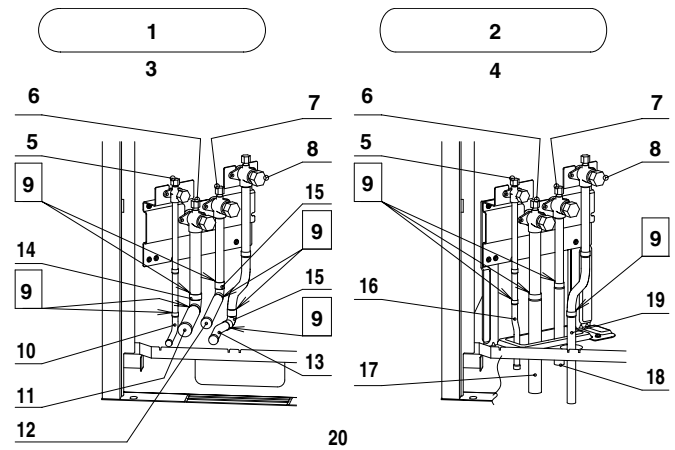

figure 12-1

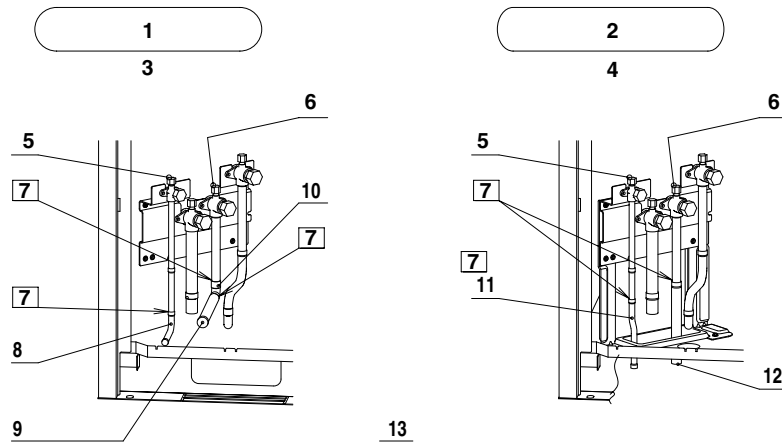

figure 12-2

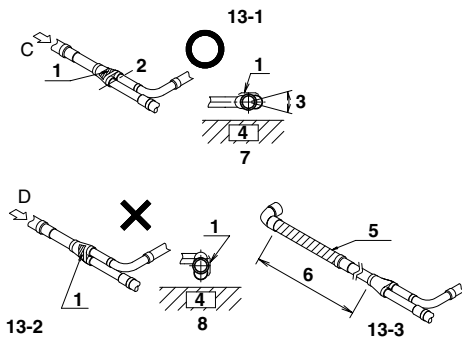

figure 13

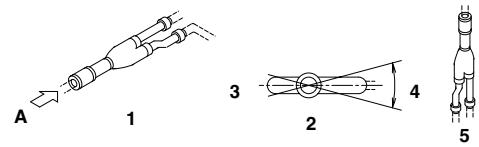

figure 14

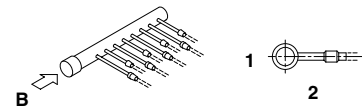

figure 15

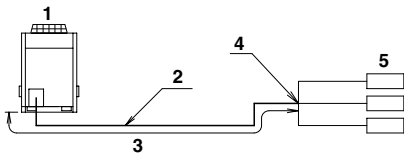

figure 16

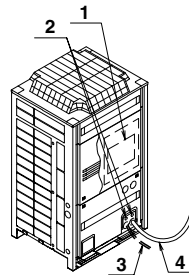

figure 18-1

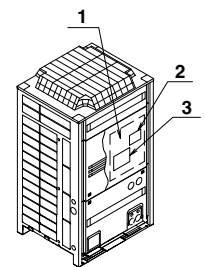

figure 18-2

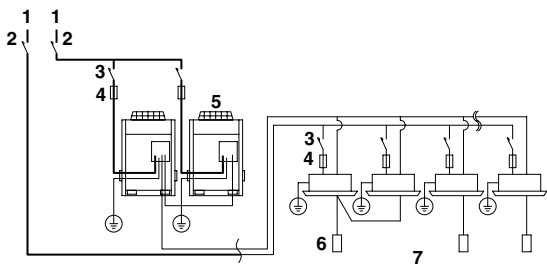

figure 17

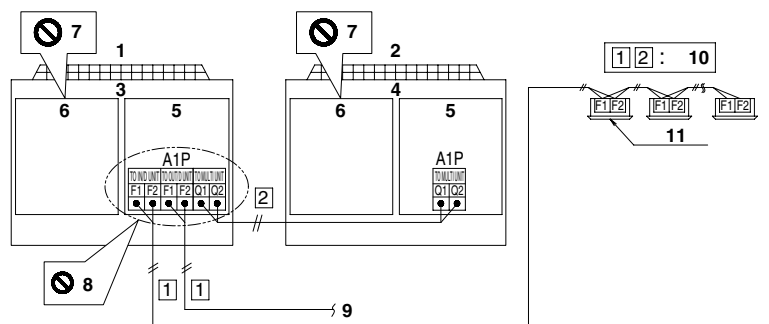

figure 19

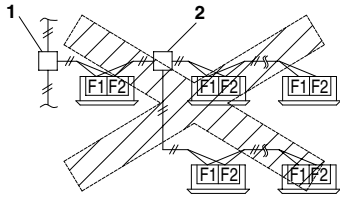

figure 20

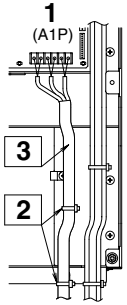

figure 21

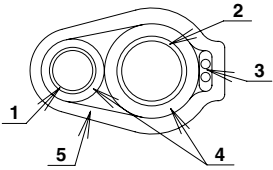

figure 22

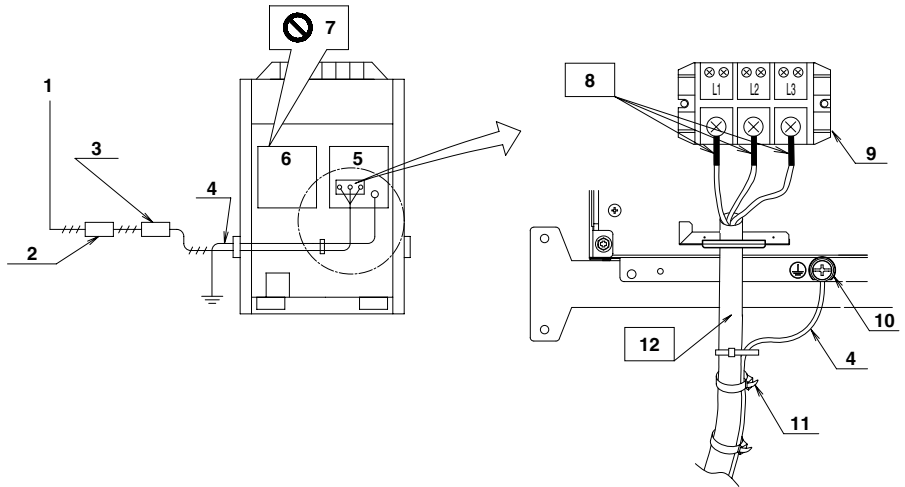

figure 23

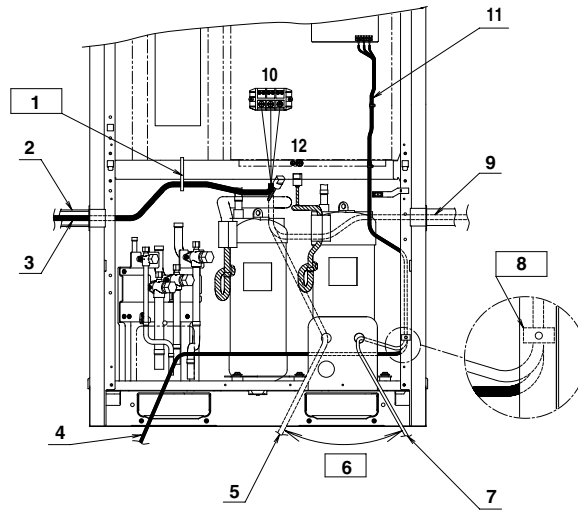

figure 24

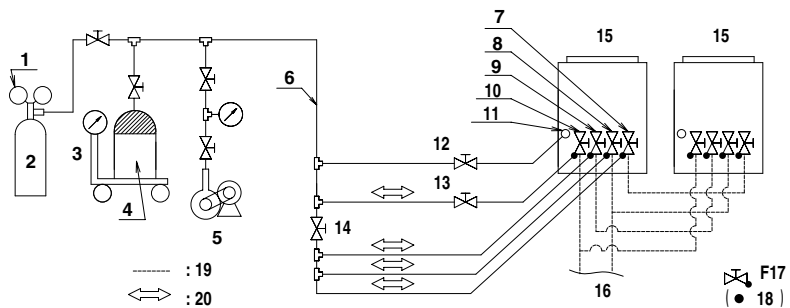

figure 25

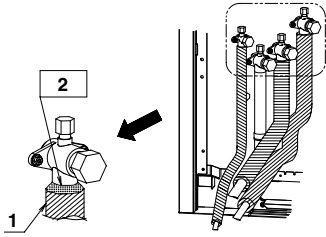

figure 26

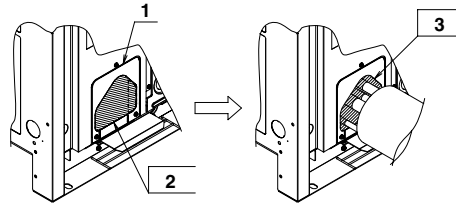

figure 27

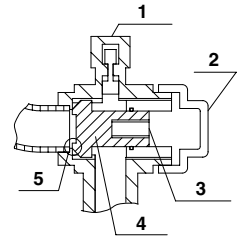

figure 28

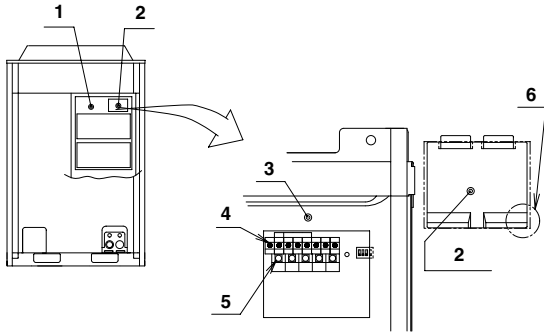

figure 29

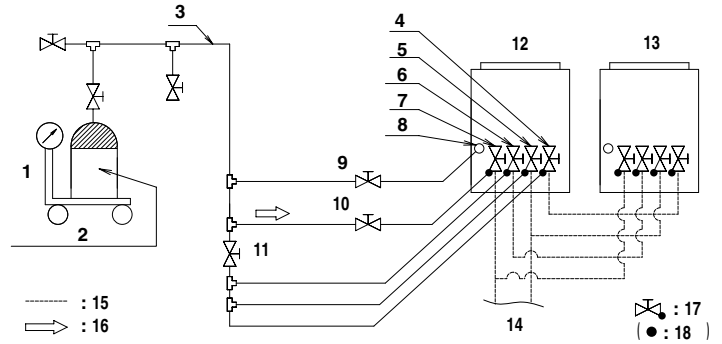

figure 30

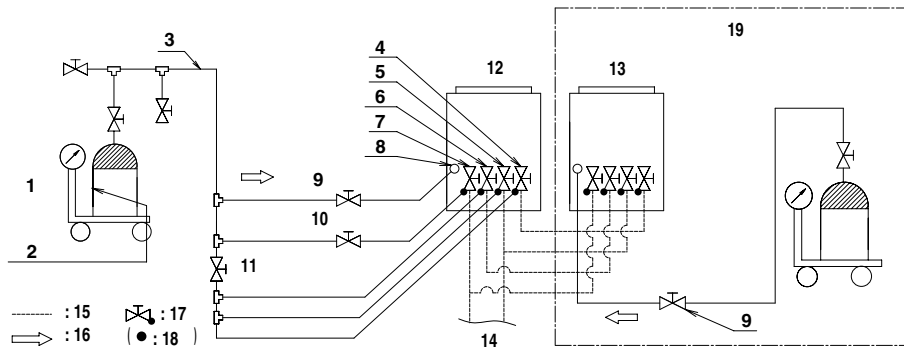

figure 31

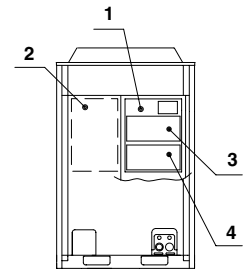

figure 32

CONTENTS

1. FIRST OF ALL	1
1-1. Safety considerations.....	1
1-2. Special notice of product.....	2
1-3. Disposal requirements	3
2. INTRODUCTION.....	3
2-1. Combination.....	3
2-2. Standard supplied accessories	3
2-3. Option accessory	3
2-4. Technical and Electrical specifications.....	3
2-5. Main components.....	3
3. SELECTION OF LOCATION	3
4. INSPECTING AND HANDLING THE UNIT	4
5. PLACING THE UNIT.....	4
6. REFRIGERANT PIPING.....	5
6-1. Selection of piping material and Refrigerant branching kit.....	5
6-2. Protection against contamination when installing pipes....	5
6-3. Pipe connection	5
6-4. Connecting the refrigerant piping.....	5
6-5. Example of connection.....	8
7. FIELD WIRING.....	11
7-1. Power circuit, safety device and cable requirements11	
7-2. Wiring Connection Example for Whole System	11
7-3. Leading wire Procedure	11
7-4. Transmission Wiring Connection Procedure.....	12
7-5. Power Wiring Connection Procedure.....	12
7-6. Procedure for Wiring Inside Units	13
8. AIR TIGHT TEST AND VACUUM DRYING.....	13
9. PIPE INSULATION	14
10. CHECKING OF DEVICE AND INSTALLATION CONDITIONS14	
11. ADDITIONAL REFRIGERANT CHARGE AND CHECK OPERATION	14
11-1. Before working.....	14
11-2. Procedure of Adding Refrigerant charging and check operation.....	15
12. ONSITE SETTINGS.....	18
13. TEST RUN	18
13-1. Before test run	18
13-2. Test Run	18
13-3. Checks After Test Run.....	19
14. CAUTION FOR REFRIGERANT LEAKS	19





1. FIRST OF ALL

- This document is an installation manual for the Daikin RXYQ-PA Series VRV Inverter. Before installing the unit, read this manual thoroughly, and following the instructions contained in it. After installation, do a test run to make sure the unit runs properly, and then explain how to operate and take care of the unit to the customer, using the operation manual. Lastly, make sure the customer keeps this manual, along with the operation manual, in a safe place.

1-1 Safety considerations

Read these "SAFETY CONSIDERATIONS for Installation" carefully before installing air conditioning equipment. After completing the installation, make sure that the unit operates properly during the startup operation. Instruct the customer on how to operate and maintain the unit. Inform customers that they should store this Installation Manual with the Operation Manual for future reference. Always use a licensed installer or contractor to install this product. Improper installation can result in water or refrigerant leakage, electrical shock, fire, or explosion.

Meanings of **DANGER**, **WARNING**, **CAUTION**, and **NOTE** Symbols:

-  **DANGER**Indicates an imminently hazardous situation which, if not avoided, will result in death or serious injury.
-  **WARNING**Indicates a potentially hazardous situation which, if not avoided, could result in death or serious injury.
-  **CAUTION**Indicates a potentially hazardous situation which, if not avoided, may result in minor or moderate injury. It may also be used to alert against unsafe practices.
-  **NOTE**.....Indicates situations that may result in equipment or property-damage accidents only.

DANGER

- Refrigerant gas is heavier than air and replaces oxygen. A massive leak can lead to oxygen depletion, especially in basements, and an asphyxiation hazard could occur leading to serious injury or death.**
- Do not ground units to water pipes, gas pipes, telephone wires, or lightning rods as incomplete grounding can cause a severe shock hazard resulting in severe injury or death. Additionally, grounding to gas pipes could cause a gas leak and potential explosion causing severe injury or death.**
- If refrigerant gas leaks during installation, ventilate the area immediately. Refrigerant gas may produce toxic gas if it comes in contact with fire. Exposure to this gas could cause severe injury or death.**
- After completing the installation work, check that the refrigerant gas does not leak throughout the system.**
- Do not install unit in an area where flammable materials are present due to risk of explosions that can cause serious injury or death.**
- Safely dispose all packing and transportation materials in accordance with federal/state/local laws or ordinances. Packing materials such as nails and other metal or wood parts, including plastic packing materials used for transportation may cause injuries or death by suffocation.**

WARNING

- Only qualified personnel must carry out the installation work. Installation must be done in accordance with this installation manual. Improper installation may result in water leakage, electric shock, or fire.**
- When installing the unit in a small room, take measures to keep the refrigerant concentration from exceeding allowable safety limits. Excessive refrigerant leaks, in the event of an accident in a closed ambient space, can lead to oxygen deficiency.**
- Use only specified accessories and parts for installation work. Failure to use specified parts may result in water leakage, electric shocks, fire, or the unit falling.**
- Install the air conditioner on a foundation strong enough that it can withstand the weight of the unit. A foundation of insufficient strength may result in the unit falling and causing injuries.**
- Take into account strong winds, typhoons, or earthquakes when installing. Improper installation may result in the unit falling and causing accidents.**
- Make sure that a separate power supply circuit is provided for this unit and that all electrical work is carried out by qualified personnel according to local state, and national regulations. An insufficient power supply capacity or improper electrical construction may lead to electric shocks or fire.**

- Make sure that all wiring is secured, that specified wires are used, and that no external forces act on the terminal connections or wires. Improper connections or installation may result in fire.
- When wiring, position the wires so that the terminal box lid can be securely fastened. Improper positioning of the terminal box lid may result in electric shocks, fire, or the terminals overheating.
- Before touching electrical parts, turn off the unit.
- Be sure to install a ground fault circuit interrupter if one is not already available. This helps prevent electrical shocks or fire.
- Securely fasten the outside unit terminal cover (panel). If the terminal cover/panel is not installed properly, dust or water may enter the outside unit causing fire or electric shock.
- When installing or relocating the system, keep the refrigerant circuit free from substances other than the specified refrigerant (R-410A) such as air. Any presence of air or other foreign substance in the refrigerant circuit can cause an abnormal pressure rise or rupture, resulting in injury.
- Do not change the setting of the protection devices. If the pressure switch, thermal switch, or other protection device is shorted and operated forcibly, or parts other than those specified by Daikin are used, fire or explosion may occur.

 **CAUTION**

- Do not touch the switch with wet fingers. Touching a switch with wet fingers can cause electric shock.
- Do not allow children to play on or around the unit to prevent injury.
- Do not touch the refrigerant pipes during and immediately after operation as the refrigerant pipes may be hot or cold, depending on the condition of the refrigerant flowing through the refrigerant piping, compressor, and other refrigerant cycle parts. Your hands may suffer burns or frostbite if you touch the refrigerant pipes. To avoid injury, give the pipes time to return to normal temperature or, if you must touch them, be sure to wear proper gloves.
- Heat exchanger fins are sharp enough to cut. To avoid injury wear glove or cover the fins when working around them.
- Install drain piping to proper drainage. Improper drain piping may result in water leakage and property damage.
- Insulate piping to prevent condensation.
- Be careful when transporting the product.
- Do not turn off the power immediately after stopping operation. Always wait for at least 5 minutes before turning off the power. Otherwise, water leakage may occur.
- Do not use a charging cylinder. Using a charging cylinder may cause the refrigerant to deteriorate.
- Refrigerant R-410A in the system must be kept clean, dry, and tight.
 - (a) Clean and Dry -- Foreign materials (including mineral oils such as SUNISO oil or moisture) should be prevented from getting into the system.
 - (b) Tight -- R-410A does not contain any chlorine, does not destroy the ozone layer, and does not reduce the earth's protection against harmful ultraviolet radiation. R-410A can contribute to the greenhouse effect if it is released. Therefore take proper measures to check for the tightness of the refrigerant piping installation. Read the chapter Refrigerant Piping and follow the procedures.
- Since R-410A is a blend, the required additional refrigerant must be charged in its liquid state. If the refrigerant is charged in a state of gas, its composition can change and the system will not work properly.
- The indoor unit is for R-410A. See the catalog for indoor models that can be connected. Normal operation is not possible when connected to other units.
- Remote controller (wireless kit) transmitting distance can be shorter than expected in rooms with electronic fluorescent lamps (inverter or rapid start types). Install the indoor unit far away from fluorescent lamps as much as possible.

- Indoor units are for indoor installation only. Outdoor units can be installed either outdoors or indoors.
- Do not install the air conditioner in the following locations:
 - (a) Where a mineral oil mist or oil spray or vapor is produced, for example, in a kitchen. Plastic parts may deteriorate and fall off or result in water leakage.
 - (b) Where corrosive gas, such as sulfurous acid gas, is produced. Corroding copper pipes or soldered parts may result in refrigerant leakage.
 - (c) Near machinery emitting electromagnetic waves. Electromagnetic waves may disturb the operation of the control system and cause the unit to malfunction.
 - (d) Where flammable gas may leak, where there is carbon fiber, or ignitable dust suspension in the air, or where volatile flammables such as thinner or gasoline are handled. Operating the unit in such conditions can cause a fire.
- Take adequate measures to prevent the outside unit from being used as a shelter by small animals. Small animals making contact with electrical parts can cause malfunctions, smoke, or fire. Instruct the customer to keep the area around the unit clean.

 **NOTE**

- Install the power supply and control wires for the indoor and outdoor units at least 3.5 feet away from televisions or radios to prevent image interference or noise. Depending on the radio waves, a distance of 3.5 feet may not be sufficient to eliminate the noise.
- Dismantling the unit, treatment of the refrigerant, oil and additional parts must be done in accordance with the relevant local, state, and national regulations.
- Do not use the following tools that are used with conventional refrigerants: gauge manifold, charge hose, gas leak detector, reverse flow check valve, refrigerant charge base, vacuum gauge, or refrigerant recovery equipment.
- If the conventional refrigerant and refrigerant oil are mixed in R-410A, the refrigerant may deteriorate.
- This air conditioner is an appliance that should not be accessible to the general public.
- The wall thickness of field-installed pipes should be selected in accordance with the relevant local, state, and national regulations.

1-2 Special notice of product

[CLASSIFICATION]

This air conditioner comes under the term "appliances not accessible to the general public".

[REFRIGERANT]

VRV^{III} System use R410A refrigerant.

- The refrigerant R410A requires strict cautions for keeping the system clean, dry and tight. Read the chapter "REFRIGERANT PIPING" carefully and follow these procedures correctly.
 - A. Clean and dry
Foreign materials (including mineral oils such as SUNISO oil or moisture) should be prevented from getting mixed into the system.
 - B. Tight
Take care to keep the system tight when installing. R410A does not contain any chlorine, does not destroy the ozone layer, and does not reduce the earth's protection against harmful ultraviolet radiation. R410A can contribute slightly to the greenhouse effect if it is released.
- Since R410A is a mixed refrigerant, the required additional refrigerant must be charged in its liquid state. If the refrigerant is charged in a state of gas, its composition changes and the system will not work properly.

[DESIGN PRESSURE]

Since design pressure is 478 psi, the wall thickness of pipes should be more carefully selected in accordance with the relevant local and national regulations.

1-3 Disposal requirements

Dismantling of the unit, treatment of the refrigerant, oil and eventual other parts, should be done in accordance with the relevant local and national regulations.

2. INTRODUCTION

- RXYQ-PA series are designed for outdoor installation and used for cooling and heating applications.
- The indoor units that combined with RXYQ-PA system for air conditioning are Daikin VRV series indoor units that compatible with R410A. To learn which indoor units are compatible with R410A, refer to the product catalogs. To combine with other refrigerant indoor unit will cause malfunction.

2-1 Combination

The system name and that independent units are as follows.

(The system name)	(Independent units)
RXYQ72PAYD/PATJ	RXYQ72PAYD/PATJ
RXYQ96PAYD/PATJ	RXYQ96PAYD/PATJ
RXYQ108PAYD/PATJ	RXYQ108PAYD/PATJ
RXYQ144PAYD/PATJ	RXYQ144PAYD/PATJ
RXYQ168PAYD/PATJ	RXYQ168PAYD/PATJ
RXYQ192PAYD/PATJ	RXYQ192PAYD/PATJ

- The indoor units can be installed in the following range.







(Outside unit)	(Total capacity index of indoor units)
RXYQ72PAYD/PATJ	43 ~ 93.5
RXYQ96PAYD/PATJ	57.5 ~ 124.5
RXYQ108PAYD/PATJ	64.5 ~ 140
RXYQ144PAYD/PATJ	86 ~ 187
RXYQ168PAYD/PATJ	100.5 ~ 218
RXYQ192PAYD/PATJ	115 ~ 249.5
- For installing the 2 units multi system, Outside unit multi connection piping kit "BHFP22P100U" are required.
- If the total capacity of the connected indoor units exceeds the capacity of the outside unit, cooling and heating performance may drop when running the indoor units. See the capacity table in the Engineering Data Book for details.









2-2 Standard supplied accessories







Confirm the following accessories are included. The storage location of the accessories is shown in figure 1.

NOTE

Do not throw away any of the accessories until installation is complete. They are needed for installation work.

Name	Clamp(1)	Clamp(2)	Clamp(3)	Vinyl tube	Conduit mounting plate	Manuals, etc.	
Quantity	8 pcs.	2 pcs.	1 pc.	4 pcs.	2 pcs.	2 pcs.	1 pc. about each item
Shape							<ul style="list-style-type: none"> Operation manual Installation manual "REQUEST FOR THE INDICATON" label (Installation records)

Name	Liquid side accessory pipe (1)	Liquid side accessory pipe (2)	Gas side accessory pipe (1)				Gas side accessory pipe (2)		
Quantity	72PA type	1 pc.	1 pc.	1 pc.				1 pc.	
	96PA type			1 pc.				1 pc.	
	108PA type			1 pc.		1 pc.		1 pc.	
Shape									

Name	High side equalizer accessory pipe (1)	High side equalizer accessory pipe (2)	Low side equalizer accessory pipe (1)	Low side equalizer accessory pipe (2)	L type accessory joint (1)	L type accessory joint (2)
Quantity	72PA type	1 pc.	1 pc.	1 pc.	1 pc.	2 pcs.
	96PA type					
	108PA type					
Shape						

(Refer to figure 1)

- Clamps, Manuals, etc.
- Accessory pipes

2-3 Option accessory

To install the outside units, the following optional parts are also required. To select an optimum kit, refer to "6. REFRIGERANT PIPING".

- Outside unit multi connection piping kit

Number of outside units connected	2 units
Kit name	BHFP22P100U

- Refrigerant branching kit

REFNET header	KHRP26M22H	KHRP26M33H	KHRP26M72H	KHRP26M73HU
REFNET joint	KHRP26M22T	KHRP26M33T	KHRP26M72TU	KHRP26M73TU

Make sure that any separately purchased accessories are designed for use with R410A.

2-4 Technical and Electrical specifications

Refer to the Engineering Data Book for the complete list of specifications.

2-5 Main components

For main components and function of the main components, refer to the Engineering Data Book.

3. SELECTION OF LOCATION

Select a location for installation that meets the following conditions and get the customer's permission.

- Select the location of the unit in such a way that neither the discharged air nor the sound generated by the unit disturb anyone.
- The foundation is strong enough to support the weight of the unit and the floor is flat to prevent vibration and noise generation.
- The piping length between the outside unit and the indoor unit may not exceed the allowable piping length.
(Refer to "6. REFRIGERANT PIPING")
- Locations where the unit's suction vent and outlet vent do not generally face the wind.
Wind blowing directly into the suction or outlet vents will interfere with the unit's operation.
If necessary, install some kind of obstruction to block the wind.

- The space around the unit is adequate for servicing and the minimum space for air inlet and air outlet is available.
(See the “Installation Space Examples” for the minimum space requirements.)

Installation Space Examples

- The installation space requirement shown in figure 2 is a reference for cooling operation when the outdoor temperature is 95°F. If the design outdoor temperature exceeds 95°F or the heat load exceeds maximum capacity in all the outside unit, take an even large space on the intake shown in figure 2.
- During installation, install the units using the most appropriate of the patterns shown in figure 2 for the location in question, taking into consideration human traffic and wind.
- If the number of units installed is more than that shown in the pattern in figure 2, install the units so there are no short circuits.
- As regards space in front of the unit, consider the space needed for the local refrigerant piping when installing the units.
- If the work conditions in figure 2 do not apply, contact your dealer or Daikin directly.

(Refer to figure 2)

- Front side
- No limit to wall height
- Service space of front side
- Service space of suction side

For Patterns 1 and 2 in figure 2 :

- Wall height for front side – no higher than 59 in.
- Wall height on the suction side – no higher than 19-5/8 in.
- Wall height for sides – no limit.
- If the height is exceeded the above, calculate h1 and h2 shown in the figure below, and add h2/2 to the service space of front side and h1/2 to the service space of suction side.

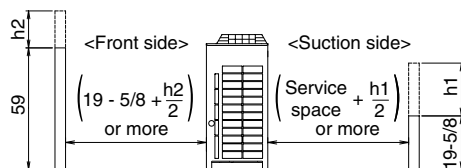

⚠ DANGER

- Do not install unit in an area where flammable materials are present due to risk of explosion resulting in serious injury or death.
- Refrigerant gas is heavier than air and replaces oxygen. A massive leak could lead to oxygen depletion, especially in basements, and an asphyxiation hazard could occur leading to serious injury or death.
Refer to the chapter “CAUTION FOR REFRIGERANT LEAKS”.

⚠ NOTE

- An inverter air conditioner may cause electronic noise generated from AM broadcasting. Examine where to install the main air conditioner and electric wires, keeping proper distances away from stereo equipment, personal computers, etc.
Particularly for locations with weak reception, ensure there is a distance of at least 10 ft for indoor remote controllers, place power wiring and transmission wiring in conduits, and ground the conduits.

(Refer to figure 3)

- Indoor unit
 - Branch switch, earth leakage circuit breaker
 - Remote controller
 - COOL/HEAT selector
 - Personal computer or radio
- When installing in locations where there is heavy snowfall, implement the following snow measures.
 - Ensure the base is high enough that intakes are not clogged by snow.
 - Remove the rear intake grille to prevent snow from accumulating on the fins.

4. INSPECTING AND HANDLING THE UNIT

- At delivery, the package should be checked and any damage should be reported immediately to the carrier claims agent.
- When handling the unit, take into account the following :

- Fragile, handle the unit with care.

 Keep the unit upright in order to avoid compressor damage.
- Decide on the transportation route.
- If a forklift is to be used, pass the forklift arms through the large openings on the bottom of the unit. (Refer to figure 4)
- If hanging the unit, use a cloth sling to prevent damaging the unit. Keeping the following points in mind, hang the unit following the procedure shown in figure 5.
 - Use a sling sufficiently strong to hold the mass of the unit.
 - Use 2 belts of at least 27 ft long.
 - Place extra cloth or boards in the locations where the casing comes in contact with the sling to prevent damage.
 - Hoist the unit making sure it is being lifted at its center of gravity.
- After installation, remove the transportation brackets (yellow) attached to the large openings. (Refer to figure 4)

(Refer to figure 4)

- Packaging material
- Forklift
- Removal of shipping brackets
- Shipping bracket (Remove the brackets by pushing the hook.)

(Refer to figure 5)

- Belt sling
- Wear plate

5. PLACING THE UNIT

- Make sure the unit is installed level on a sufficiently strong base to prevent vibration and noise. (Refer to figure 6)
- The base should support the unit with the extent larger than hatched area in figure 7.
If protective rubber is to be attached, attach it to the whole face of the base.
- The height of the base should be at least 5-7/8 in. from the floor.
- Secure the unit to its base using foundation bolts. (Use four commercially available M12-type foundation bolts, nuts, and washers.)
- The foundation bolts should be inserted 13/16 in..

(Refer to figure 6)

- Independent base (four corner type)
- Independent base (with center support type)
- Beam base (Horizontal)
- Beam base (Vertical)
- Center of the product

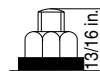

(Refer to figure 7)

- Foundation bolt point (φ9/16 in. dia. : 4positions)
- (Depth of product)
- (Inner dimension of the base)
- (Outer dimension of the base)

Model	A (in.)	B (in.)
72 · 96 · 108PA type	48-13/16	43-3/8

⚠ NOTE

- There are restrictions on the refrigerant pipe connecting order between outside unit in the case of the multi system. See “2-1 Combination” for detail.
- When installing on a roof, make sure the roof floor is strong enough and be sure to water-proof all work.
- Make sure the area around the machine drains properly by setting up drainage grooves around the foundation.
Drain water is sometimes discharged from the outside unit when it is running.
- For anti-corrosion type, use nuts with resin washers. If the paint on nut connections comes off, the anti-corrosion effect may decrease.

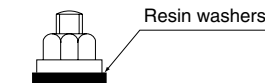

6. REFRIGERANT PIPING



NOTE

- All field piping must be installed by a licensed refrigeration technician and must comply with relevant local and national regulations.
- After piping work is complete, do not under any circumstances open the shutoff valve until “7. FIELD WIRING” and “10. CHECKING OF DEVICE AND INSTALLATION CONDITIONS” are complete.
- Do not use flux when brazing the refrigerant piping. Use the phosphor copper brazing filler metal (B-Cu93P-710/795 : ISO 3677) which does not require flux.

(Flux has extremely negative effect on refrigerant piping systems. For instance, if the chlorine based flux is used, it will cause pipe corrosion or, in particular, if the flux contains fluorine, it will damage the refrigerant oil.)

6-1 Selection of piping material and Refrigerant branching kit

- Use only pipes which are clean inside and outside and which do not accumulate harmful sulfur, oxidants, dirt, cutting oils, moisture, or other contamination. (Foreign materials inside pipes including oils for fabrication must be 9 mg/10 ft or less.)
- Use the following items for the refrigerant piping.

Material : Jointless phosphor-deoxidized copper pipe

Size : See “6-5 Example of connection” to determine the correct size.

Thickness : Select a thickness for the refrigerant piping which complies with national and local laws.

- For piping work, follow the maximum tolerated length, difference in height, and length after a branch indicated in the “6-5 Example of connection”.
- Outside unit multi connection piping kit and refrigerant branching kit (sold separately) are needed for connection of piping between outside units (in case of multi system) and piping branches. Use only separately sold items selected specifically according to the outside unit multi connection piping kit, the refrigerant branching kit selection in the “6-5 Example of connection”.

6-2 Protection against contamination when installing pipes

Protect the piping to prevent moisture, dirt, dust, etc. from entering the piping.

Place	Installation period	Protection method
Outdoor	More than a month	Pinch the pipe
	Less than a month	Pinch or tape the pipe
Indoor	Regardless of the period	



NOTE

Exercise special caution to prevent dirt or dust when passing piping through holes in walls and when passing pipe edges to the exterior.

6-3 Pipe connection

- Be sure to perform nitrogen permutation or nitrogen blow when brazing. (Refer to figure 8)
Brazing without performing nitrogen permutation or nitrogen blow into the piping will create large quantities of oxidized film on the inside of the pipes, adversely affecting valves and compressors in the refrigerating system and preventing normal operation.

(Refer to figure 8)

- Refrigerant pipe
 - Location to be brazed
 - Nitrogen
 - Taping
 - Handy valve
 - Regulator
- The pressure regulator for the nitrogen released when doing the brazing should be set to about 2.9 psi (Enough to feel a slight breeze on your cheek).



NOTE

Do not use anti-oxidants when brazing the pipe joints. Residue can clog pipes and break equipment.

6-4 Connecting the refrigerant piping

1. Direction to bring out the pipes

The local inter unit piping can be connected either forward or to the sides (taken out through the bottom) as shown in the figure 9. When passing out through the bottom, use the knock hole in the bottom frame.

(Refer to figure 9)

- Left-side connection
- Front connection
- Right-side connection

Precautions when knocking out knock holes

- Open knock hole (large, small) in the base frame by drilling the 4 concave around it with a $\phi 1/4$ "-bit. (Refer to figure 10)

(Refer to figure 10)

- Knock hole (large : for liquid pipe, gas pipe and low side equalizer pipe)
 - Knock hole (small : for high side equalizer pipe)
 - Drill
 - Concave section (4 points)
- Be sure to avoid damaging the casing.
 - After knocking out the holes, we recommend you to remove any burrs and paint them using the repair paint to prevent rusting.
 - When passing electrical wiring through the knock holes, protect the wiring with a conduit or bushings, making sure not to damage the wiring.
- #### 2. Removing Pinch Piping
- When connecting refrigerant piping to an outside unit, remove the pinch piping using the procedure in the figure 11. (Refer to figure 11)
 - About handling of shutoff valves, refer to [Shutoff valve operation procedure] in “11-1 Before working”.



CAUTION

After removing the gass, remove the pinch piping. Any gas remaining inside may blow off the pinch piping when you dissolve the brazing, causing damage.

(Refer to figure 11)

- Pinch piping (4 pieces)
 - Do not remove the relay piping.
 - Pinch piping
 - Procedure 1 : Confirm the shutoff valve is closed.
 - Procedure 2 : Connect a charge hose to the service port of shutoff valve and remove the gas in the pinch piping.
 - Procedure 3 : After removing the gas in the pinch piping, dissolve the brazing using a burner and remove the pinch piping.
- #### 3. Connecting refrigerant piping to outside units
- Figure 12-1, 2 shows the example of connecting refrigerant piping to outside units.
 - The local inter unit piping next accessory pipes are field supplied.
 - About the detail of connecting pipes between outside units on outside unit multi system, refer to the “4. Precautions when connecting piping between outside units” and the installation manual attached to the outside unit multi connection piping kit.

(Refer to figure 12-1)

- When connected to the front
- When connected at lateral side (bottom)
- Remove the shutoff valve cover to connect.
- Remove the knock hole on the bottom frame and route the piping under the bottom frame.
- Liquid pipe shutoff valve
- Low side equalizer pipe shutoff valve
- Gas pipe shutoff valve
- High side equalizer pipe shutoff valve
- Brazing
- Liquid side accessory pipe (1)
- Low side equalizer accessory pipe (1)
- Gas side accessory pipe (1)

13. High side equalizer accessory pipe (1)
14. L type accessory joint (1)
15. L type accessory joint (2)
16. Liquid side accessory pipe (2)
17. Low side equalizer accessory pipe (2)
18. Gas side accessory pipe (1)
19. High side equalizer accessory pipe (2)
20. Installation for multi system

(Refer to figure 12-2)

1. When connected to the front
2. When connected at lateral side (bottom)
3. Remove the shutoff valve cover to connect.
4. Remove the knock hole on the bottom frame and route the piping under the bottom frame.
5. Liquid pipe shutoff valve
6. Gas pipe shutoff valve
7. Brazing
8. Liquid side accessory pipe (1)
9. Gas side accessory pipe (1)
10. L type accessory joint (2)
11. Liquid side accessory pipe (2)
12. Gas side accessory pipe (1)
13. Installation for single unit system

NOTE

- Equalizer pipe is only for connection between outside units on multi outside unit system.
That is not connect to indoor units.
- Make sure the onsite piping does not come into contact with other piping or the bottom frame or side panels of the unit.

4. Precautions when connecting piping between outside units

The Outside unit multi connection piping kit (sold separately) is needed to connect piping between outside units in multi system. Only proceed with piping work after considering the limitations on installation listed here and in “**5. Branching the refrigerant piping**”, always referring to the kit’s installation manual.

(1) About outside unit multi connection piping kit

- Install the joint horizontally so that the attached warning label faces straight up, and the tilt is within $\pm 15^\circ$. **(Refer to figure 13-1)**
Do not install vertically. **(Refer to figure 13-2)**
- Maintain a straight portion of 19-5/8 in. or more until the split of the joint without wrapping any onsite piping around this area. Over 19-5/8 in. of straight area can be maintained by connecting at least 4-3/4 in. of onsite pipe (straight) to the joint. **(Refer to figure 13-3)**

(Refer to figure 13)

1. Warning label
2. Horizontal surface
3. $\pm 15^\circ$ or less
4. Ground
5. Onsite pipe (4-3/4 in. length or more)
6. Straight part of 19-5/8 in. or more
7. C-arrow view
8. D-arrow view

(2) The piping between outside units must be installed level (Pattern 1) or with a rise (Pattern 2). Otherwise oil may pool in the pipes.

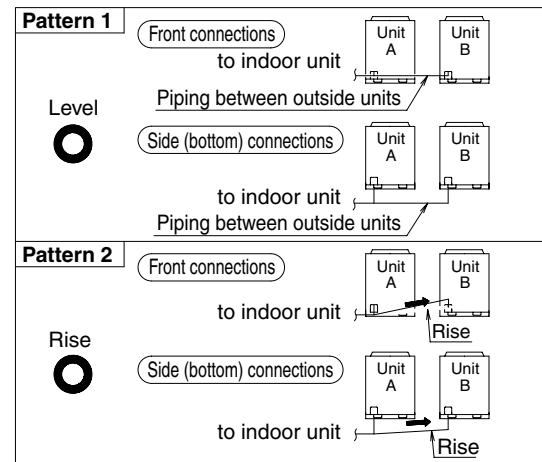

Change to pattern 1 or pattern 2

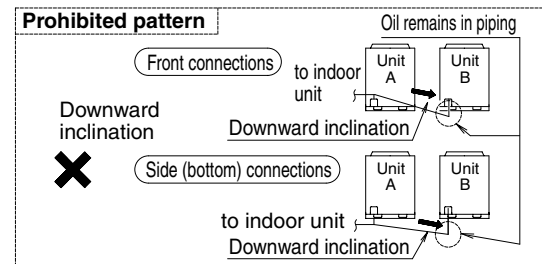

(3) To avoid the risk of oil detention in the stopping unit, always connect the shutoff valve and the piping between outside units as shown A or B in the figure below.

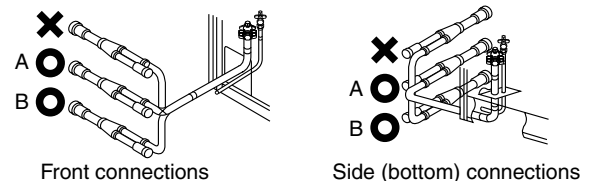

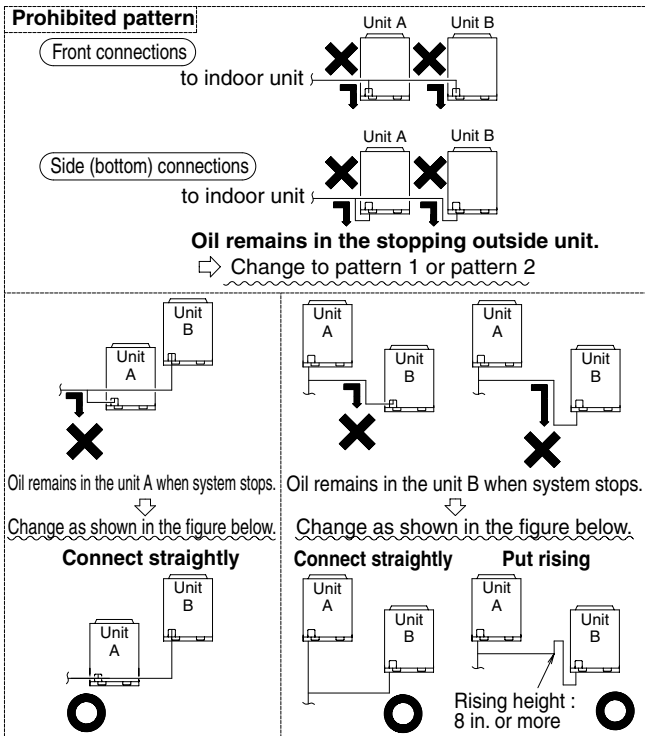

(4) If the piping length between the outside units exceeds 80 in., create a rise of 8 in. or more in the gas piping under a length of 80 in. from the outside unit multi connection piping kit.

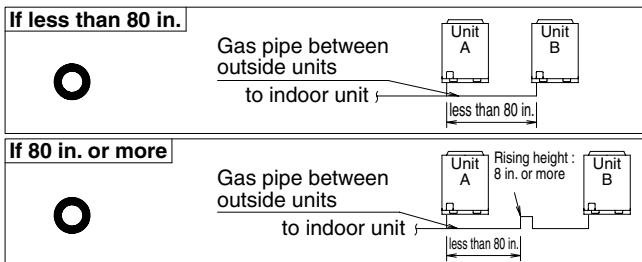

5. Branching the refrigerant piping

Heed the restrictions below when installing the refrigerant branching kit and read the installation instruction manual with the kit. (Improper installation could lead to malfunctioning or breakdown of the outside unit.)

<REFNET joint>

Install the REFNET joint so it splits horizontally or vertically.

(Refer to figure 14)

1. Horizontal
2. A-arrow view
3. Horizontal surface
4. $\pm 30^\circ$ or less
5. Vertical



<REFNET header>

Install the REFNET header so it splits horizontally.

(Refer to figure 15)

1. Horizontal surface
2. B-arrow view

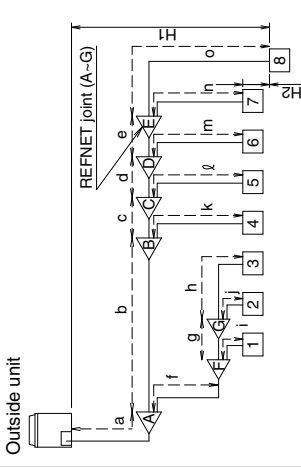
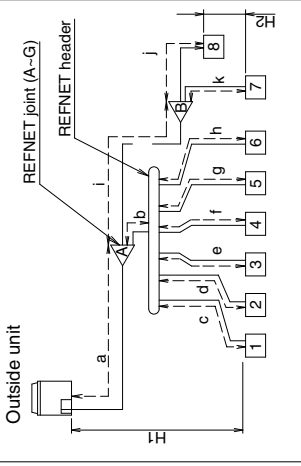
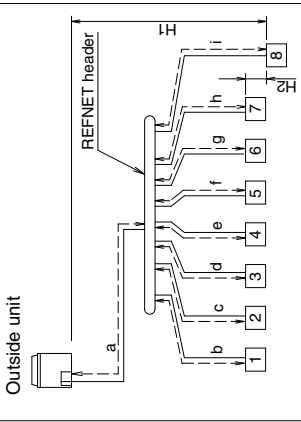
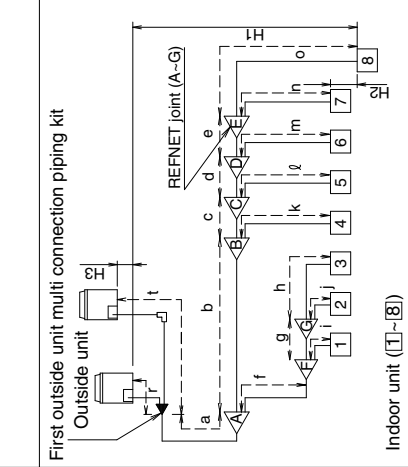
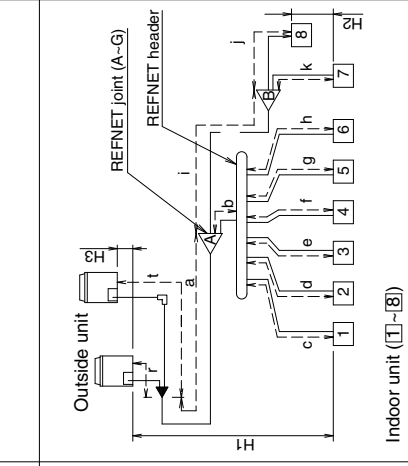
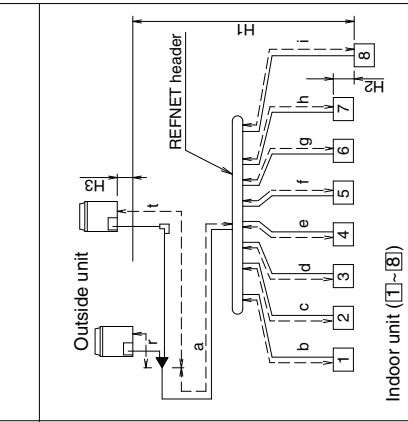
6-5 Example of connection

<p>Example of connection (Connection of 8 indoor units) (*1) "←" Indicate the Outside unit multi connection piping kit. (*2) In case of multi outdoor system, re-read "outside unit" to "the first Outside unit multi connection piping kit" as seen from the indoor unit.</p>	<p>Single outside system (R17072-1069A10) (R17072-1069A11)</p>	<p>Branch with REFNET joint</p>  <p>Outside unit</p> <p>REFNET joint (A-G)</p> <p>Indoor unit (1)~(8)</p>	<p>Branch with REFNET joint and header</p>  <p>Outside unit</p> <p>REFNET joint (A-G)</p> <p>REFNET header</p> <p>Indoor unit (1)~(8)</p>	<p>Branch with REFNET header</p>  <p>Outside unit</p> <p>REFNET header</p> <p>Indoor unit (1)~(8)</p>
<p>Multi outside system (R17044-1069A10) (R17044-1069A11)</p>	<p>First outside unit multi connection piping kit</p>  <p>First outside unit multi connection piping kit</p> <p>REFNET joint (A-G)</p> <p>Indoor unit (1)~(8)</p>	<p>Branch with REFNET joint and header</p>  <p>Outside unit</p> <p>REFNET joint (A-G)</p> <p>REFNET header</p> <p>Indoor unit (1)~(8)</p>	<p>Branch with REFNET header</p>  <p>Outside unit</p> <p>REFNET header</p> <p>Indoor unit (1)~(8)</p>	
<p>Actual pipe length</p> <p>Equivalent length</p> <p>Total extension length</p>	<p>Pipe length between outside unit (*2) and indoor unit ≤ 540 ft</p> <p>Example [8] : a + b + c + d + e + o ≤ 540 ft</p> <p>Equivalent pipe length between outside unit (*2) and indoor unit ≤ 620 ft (Note 1)</p> <p>(Assume equivalent pipe length of REFNET joint to be 1.6 ft, that of REFNET header to be 3.3 ft, for calculation purposes)</p> <p>Total piping length from outside unit (*2) to all indoor unit ≤ 3280 ft</p>	<p>Example [6] : a + b + h ≤ 540 ft, [8] : a + i + j ≤ 540 ft</p> <p>Example [8] : a + i ≤ 540 ft</p>	<p>Example [6] : a + b + h ≤ 540 ft, [8] : a + i + j ≤ 540 ft</p> <p>Example [8] : a + i ≤ 540 ft</p>	
<p>Maximum allowable length</p>	<p>Actual pipe length from first outside unit multi connection piping kit to outside unit ≤ 33 ft</p> <p>Equivalent pipe length from first outside unit multi connection piping kit to outside unit ≤ 43 ft</p>	<p>Outside unit</p>  <p>r ≤ 33 ft (Equivalent length ≤ 43 ft)</p> <p>t ≤ 33 ft (Equivalent length ≤ 43 ft)</p>	<p>Outside unit</p>  <p>r ≤ 33 ft (Equivalent length ≤ 43 ft)</p> <p>t ≤ 33 ft (Equivalent length ≤ 43 ft)</p>	
<p>Allowable height difference</p>	<p>Difference in height between outside unit and indoor units (H1) ≤ 164 ft (Max 130 ft if the outside unit is below)</p> <p>Difference in height between adjacent indoor units (H2) ≤ 49 ft</p> <p>Difference in height between adjacent outside units (H3) ≤ 16 ft</p>	<p>Actual pipe length from first outside unit multi connection piping kit to indoor unit ≤ 130 ft (Note 2)</p> <p>Example [6] : b + h ≤ 130 ft, [8] : i + j ≤ 130 ft</p>	<p>Actual pipe length from first refrigerant branch kit (either REFNET joint or REFNET header) to indoor unit ≤ 130 ft (Note 2)</p> <p>Example [6] : b + h ≤ 130 ft, [8] : i + j ≤ 130 ft</p>	
<p>Allowable length after the branch</p>	<p>Actual pipe length</p>	<p>Example [8] : b + c + d + e + o ≤ 130 ft</p>	<p>Example [8] : i ≤ 130 ft</p>	

Outside unit multi connection piping kit and Refrigerant branch kit selection

- Refrigerant branch kits can only be used with R410A.
- When multi outdoor system are installed, be sure to use the special separately sold Outside unit multi connection piping kit. (BHFP22P100U.)
- Never use BHFP22M90U, BHFP22M90U for M type of this series or T joint. (field supplied).

Example for indoor units connected downstream

Pipe size selection

The thickness and material shall be selected in accordance with local code.

For an outside unit installation, make the settings in accordance with the following figure.

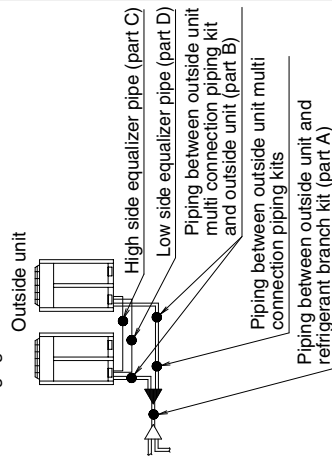

How to select the REFNET joint

- When using REFNET joint at the first branch counted from the outside unit side, choose from the following table in accordance with the outside unit capacity type. (Example : REFNET jointA)

Outside unit capacity type	Refrigerant branch kit name
RXYQ72 - 96PA type	KHRP26M33T
RXYQ108 ~ 192PA type	KHRP26M72TU

Choose the REFNET joints other than the first branch from the following table in accordance with the total capacity index of all the indoor units connected below the REFNET joint.

Indoor unit total capacity index	Refrigerant branch kit name
x < 72	KHRP26M22T
72 ≤ x < 111	KHRP26M33T
111 ≤ x	KHRP26M72TU

How to select the REFNET header

- Choose from the following table in accordance with the total capacity index of all the indoor units connected below the REFNET header.

Indoor unit total capacity index	Refrigerant branch kit name
x < 72	KHRP26M22H or KHRP26M33H
72 ≤ x < 111	KHRP26M33H
111 ≤ x	KHRP26M72H

How to select the outside unit multi connection piping kit (This is required when the system is multi outside unit system.)

- Choose from the following table in accordance with the number of outside units.
- | Number of outside unit | Connecting piping kit name |
|------------------------|----------------------------|
| 2 units | BHFP22P100U |

Example REFNET joint C : Indoor units [5]+[6]+[7]+[8]
Example REFNET header : Indoor units [7]+[8]

Piping between outside unit (2) and refrigerant branch kit (partA)

- Choose from the following table in accordance with the outside units system capacity type. (unit : in.)

Outside unit capacity type	Piping size (O. D.)	
	Gas pipe	Liquid pipe
RXYQ72PA type	φ3/4	φ3/8
RXYQ96PA type	φ7/8	φ3/8
RXYQ108PA type	φ1-1/8	φ1/2
RXYQ144PA type		φ5/8
RXYQ168PA type	φ1-1/8	φ5/8
RXYQ192PA type		φ5/8

Piping between outside unit multi connection piping kit and outside unit (part B)

- Choose from the following table in accordance with the capacity type of the outside unit connected. (unit : in.)

Outside unit capacity type	Piping size (O. D.)	
	Gas pipe	Liquid pipe
RXYQ72PA type	φ3/4	φ3/8
RXYQ96PA type	φ7/8	φ3/8

Example REFNET header : Indoor units [1]+[2]+[3]+[4]+[5]+[6]+[7]+[8]

Piping between refrigerant branch kits

- Choose from the following table in accordance with the total capacity type of all the indoor units connected downstream.

*1 Connection piping must not exceed the refrigerant Piping size between outside unit and refrigerant branch kit (partA) (unit : in.)

Indoor capacity index	Piping size (O. D.)	
	Gas pipe	Liquid pipe
x < 54	φ5/8	φ3/8
54 ≤ x < 72	φ3/4	φ3/8
72 ≤ x < 111	φ7/8	φ1/2
111 ≤ x < 162	φ1-1/8	φ5/8
162 ≤ x	φ1-1/8	φ5/8

Piping between refrigerant branch kit and indoor unit.

- Match to the size of the connection piping on the indoor unit. (unit : in.)

Indoor unit capacity type	Piping size (O. D.)	
	Gas pipe	Liquid pipe
07 · 09 · 12 · 18	φ1/2	φ1/4
24 · 30 · 36 · 48	φ5/8	φ3/8

High side Equalizer pipe (part C)(outside multi system only) (unit : in.)

Piping size (O. D.) φ3/4

Low side Equalizer pipe (part D)(outside multi system only) (unit : in.)

Piping size (O. D.) φ3/4

How to calculate the additional refrigerant to be charged

Additional refrigerant to be charged : R(lb)
(R should be rounded)
(off in units of 0.1 lb.)

$$R = \left(\frac{\text{Total length (ft) of liquid piping size at } \phi 3/8}{\phi 3/8} \times 0.249 + \frac{\text{Total length (ft) of liquid piping size at } \phi 3/4}{\phi 3/4} \times 0.175 \right) + \left(\frac{\text{Total length (ft) of liquid piping size at } \phi 5/8}{\phi 5/8} \times 0.121 + \frac{\text{Total length (ft) of liquid piping size at } \phi 1/2}{\phi 1/2} \times 0.081 \right) + \left(\frac{\text{Total length (ft) of liquid piping size at } \phi 3/8}{\phi 3/8} \times 0.040 + \frac{\text{Total length (ft) of liquid piping size at } \phi 1/4}{\phi 1/4} \times 0.015 \right)$$

HEAT PUMP SYSTEM		REFRIGERANT AMOUNT FOR EXCEEDING CONNECTION CAPACITY OF INDOOR UNIT	
MODEL NAME	THE AMOUNT OF REFRIGERANT	INDOOR CONNECTION CAPACITY	MODEL NAME
RXYQ72 ~ 108PAYD	—	MORE THAN 100%	RXYQ72 ~ 192PAYD
RXYQ72 ~ 108PATJ	—	120% OR LESS	RXYQ72 ~ 192PATJ
RXYQ144 ~ 192PAYD	2.2 lb	MORE THAN 120%	1.1 lb
RXYQ144 ~ 192PATJ	2.2 lb	130% OR LESS	1.1 lb

Example for refrigerant branch using REFNET joint and REFNET header for systems and each pipe length as shown below.

Outside system : RXYQ192PAYD
Total capacity of indoor unit : 116%

a. : $\phi 3/4 \times 15\text{ft.}$	e. : $\phi 3/8 \times 5\text{ft.}$	i. : $\phi 3/8 \times 5\text{ft.}$	m. : $\phi 3/8 \times 10\text{ft.}$	r. : $\phi 1/2 \times 1\text{ft.}$
b. : $\phi 3/4 \times 10\text{ft.}$	f. : $\phi 3/8 \times 5\text{ft.}$	j. : $\phi 3/8 \times 5\text{ft.}$	n. : $\phi 3/8 \times 5\text{ft.}$	s. : $\phi 3/8 \times 1\text{ft.}$
c. : $\phi 3/8 \times 5\text{ft.}$	g. : $\phi 3/8 \times 5\text{ft.}$	k. : $\phi 3/8 \times 10\text{ft.}$	o. : $\phi 1/4 \times 5\text{ft.}$	t. : $\phi 3/8 \times 1\text{ft.}$
d. : $\phi 3/8 \times 5\text{ft.}$	h. : $\phi 3/8 \times 5\text{ft.}$	l. : $\phi 3/8 \times 10\text{ft.}$	p. : $\phi 1/4 \times 5\text{ft.}$	u. : $\phi 5/8 \times 1\text{ft.}$

$$R = \left(\frac{25 \times 0.175}{\phi 3/8} + \frac{1 \times 0.121}{\phi 3/4} + \frac{1 \times 0.081}{\phi 1/2} + \frac{10 \times 0.040}{\phi 3/8} + \frac{22 + 1.1}{\phi 1/4} \right) + \frac{2.2}{\phi 3/8} + \frac{1.1}{\phi 1/4}$$

$$= 11.027 \Rightarrow \boxed{11.0\text{lb}}$$

Round off in units of 0.1 lb.

Note 1. When the equivalent pipe length between outside and indoor units is 295 ft or more, the size of main pipes (both gas side and liquid side (refer to figure 16) must be increased according to the right table.

1. Outdoor unit
2. Main pipes
3. Increase
4. First refrigerant branch kit
5. Indoor unit

Note 2. Allowable length after the first refrigerant branch kit to indoor units is 130 ft or less, however it can be extended up to 295 ft if all the following conditions are satisfied. (In case of "Branch with REFNET joint")

System	Gas pipe	Liquid pipe
RXYQ72PA type	$\phi 3/4 \rightarrow \phi 7/8$	$\phi 3/8 \rightarrow \phi 1/2$
RXYQ96PA type	$\phi 7/8 \rightarrow \phi 1$	$\phi 3/8 \rightarrow \phi 1/2$
RXYQ108PA type	Not Increased	$\phi 1/2 \rightarrow \phi 5/8$
RXYQ144PA type	$\phi 1-1/8 \rightarrow \phi 1-1/4$	$\phi 1/2 \rightarrow \phi 5/8$
RXYQ168PA type	$\phi 1-1/8 \rightarrow \phi 1-1/4$	$\phi 5/8 \rightarrow \phi 3/4$
RXYQ192PA type	$\phi 1-1/8 \rightarrow \phi 1-1/4$	$\phi 5/8 \rightarrow \phi 3/4$

Required Conditions

1. It is necessary to increase the pipe size between the first branch kit and the final branch kit. (Reducers must be procured on site) However, the pipes that are same pipe size with main pipe must not be increased

2. For calculation of Total extension length, the actual length of above pipes must be doubled. (except main pipe and the pipes that are not increased)

3. Indoor unit to the nearest branch kit ≤ 130 ft.

4. The difference between [Outside unit to the farthest indoor unit] and [Outside unit to the nearest indoor unit] ≤ 130 ft.

*If available on the site, use this size. Otherwise it can not be increased.

Example Drawings

Increase the pipe size as follows
 $\phi 3/8 \rightarrow \phi 1/2$
 $\phi 1/2 \rightarrow \phi 5/8$
 $\phi 5/8 \rightarrow \phi 3/4$
 $\phi 3/4 \rightarrow \phi 7/8$
 $\phi 7/8 \rightarrow \phi 1^*$
 $\phi 1-1/8 \rightarrow \phi 1-1/4^*$

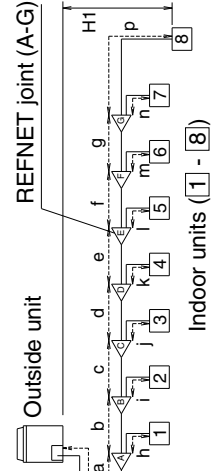

7. FIELD WIRING

NOTE

- All field wiring and components must be installed by a licensed electrician and must comply with relevant local and national regulations.
- Be sure to use a dedicated power circuit. Never use a power supply shared by another appliance.
- Never install a phase advancing capacitor. As this unit is equipped with an inverter, installing a phase advancing capacitor will not only deteriorate power factor improvement effect, but also may cause capacitor abnormal heating accident due to high-frequency waves.
- Only proceed with wiring work after blocking off all power.
- Always ground wires in accordance with relevant local and national regulations.
- This machine includes an inverter device. Connect earth and leave charge to eliminate the impact on other devices by reducing noise generated from the inverter device and to prevent leaked current from being charged in the outer hull of the product.
- Do not connect the ground wire to gas pipes, sewage pipes, lightning rods, or telephone ground wires.

Gas pipes : can explode or catch fire if there is a gas leak.

Sewage pipes : no grounding effect is possible if hard plastic piping is used.

Telephone ground wires and lightning rods : dangerous when struck by lightning due to abnormal rise in electrical potential in the grounding.

- Be sure to install an earth leakage circuit breaker. This unit uses an inverter, so install the earth leakage circuit breaker that be capable of handling high harmonics in order to prevent malfunctioning of the earth leakage circuit breaker itself.
- Earth leakage circuit breaker which are especially for protecting ground-faults should be used in conjunction with main switch or fuse for use with wiring.
- Electrical wiring must be done in accordance with the wiring diagrams and the description herein.
- Do not operate until refrigerant piping work is completed. (If operated before complete the piping work, the compressor may be broken down.)
- Never remove thermistor, sensor or etc. when connecting power wiring and transmission wiring. (If operated with thermistor, sensor or etc. removed, the compressor may be broken down.)
- This product have reversed phase protection detector that only works when the power is turned on. If there exists blackout or the power goes on and off which the product is operating, attach a reversed phase protection circuit locally. Running the product in reversed phase may break the compressor and other parts.
- Attach the power wire securely. Introducing power with a missing N-phase or with a mistaken N-phase will break the unit.
- Never connect the power supply in reversed phase. The unit can not operate normally in reversed phase. If you connect in reversed phase, replace two of the three phases.
- Make sure the electrical unbalance ratio is no greater than 2%. If it is larger than this, the unit's lifespan will be reduced. If the ratio exceeds 4%, the unit will shut down and an malfunction code will be displayed on the indoor remote controller.
- Connect the wire securely using designated wire and fix it with attached clamp without applying external pressure on the terminal parts (terminal for power wiring, terminal for transmission wiring and earth terminal).
- If there exists the possibility of reversed phase, lose phase, momentary blackout or the power goes on and off while the product is operating, attach a reversed phase protection circuit locally. Running the product in reversed phase may break the compressor and other parts.

7-1 Power circuit, safety device and cable requirements

- A power circuit (see the following table) must be provided for connection of the unit. This circuit must be protected with the required safety devices, i.e. a main switch, a slow blow fuse on each phase and an earth leakage circuit breaker.
- When using residual current operated circuit breakers, be sure to use a high-speed type (0.1 second or less) 200mA rated residual operating current.
- Use copper conductors only.

- Use insulated wire for the power cord.
- Select the power supply cable type and size in accordance with relevant local and national regulations.
- Specifications for local wiring power cord and branch wiring are in compliance with local cord.

	Phase and frequency	Voltage	Minimum circuit amp.	Recommended fuses	Transmission line selection
RXYQ72PAYD	φ 3, 60Hz	460V	20.2A	25A	AWG18-16
RXYQ96PAYD	φ 3, 60Hz	460V	20.3A	25A	AWG18-16
RXYQ108PAYD	φ 3, 60Hz	460V	20.5A	30A	AWG18-16
RXYQ144PAYD	φ 3, 60Hz	460V	40.4A	25A+25A	AWG18-16
RXYQ168PAYD	φ 3, 60Hz	460V	40.5A	25A+25A	AWG18-16
RXYQ192PAYD	φ 3, 60Hz	460V	40.6A	25A+25A	AWG18-16
RXYQ72PATJ	φ 3, 60Hz	208-230V	36.1A	40A	AWG18-16
RXYQ96PATJ	φ 3, 60Hz	208-230V	36.1A	50A	AWG18-16
RXYQ108PATJ	φ 3, 60Hz	208-230V	41.3A	60A	AWG18-16
RXYQ144PATJ	φ 3, 60Hz	208-230V	72.2A	40A+40A	AWG18-16
RXYQ168PATJ	φ 3, 60Hz	208-230V	72.2A	40A+50A	AWG18-16
RXYQ192PATJ	φ 3, 60Hz	208-230V	72.2A	50A+50A	AWG18-16

7-2 Wiring Connection Example for Whole System

(Refer to figure 17)

1. Power supply
2. Main switch
3. Earth leakage circuit breaker
4. Fuse
5. Outside unit
6. Remote controller
7. Indoor unit

NOTE

- Make sure the weak electric wiring (i.e. for the remote controller, between units, etc.) and the power wiring do not pass near each other, keeping them at least 2 in. apart. Proximity may cause electrical interference, malfunctions, and breakage.
- Be sure to connect the power wiring to the power wiring terminal block and secure it as described in "7-5 Power Wiring Connection Procedure".
- Transmission wiring should be secured as described in "7-4 Transmission Wiring Connection Procedure".
- Secure wiring with clamp such as insulation lock ties to avoid contact with piping.
- Shape the wires to prevent the structure such as the EL. COMPO. BOX lid deforming. And close the cover firmly.
- All field wiring is to be procured on site.

7-3 Leading wire Procedure

- The power wiring and ground wiring are passed out from the power wiring hole on the sides, the front (knock hole) or the bottom frame (knock hole) .
- The transmission wiring is passed out from the wiring hole (knock hole) on the front of the unit or from a piping hole.

(Refer to figure 18-1)

1. Electric wiring diagram
Printed on the back of the EL. COMPO. BOX lid.
2. Knockout hole
3. Power line
4. Transmission line

(Refer to figure 18-2)

1. EL. COMPO. BOX lid
2. Service lid
3. [Service precautions] Label location

NOTE

- Open the knock holes with a hammer or the like.
- After knocking out the holes, we recommend you remove any burrs and paint them using the repair paint to prevent rusting. (Refer to figure 18-1, 2)
- When passing wiring through the knock holes, remove burrs around the knock holes and protect the wiring with protective tape. (Refer to figure 18-1, 2)
- If small animals might enter the unit, block off any gaps (hatching parts in figure 18-1, 2) with material (field supply).

7-4 Transmission Wiring Connection Procedure

- Referring to figure 19 connect the transmission wiring between outside unit and indoor unit, outside unit and outside unit of other system, outside unit and outside unit of same system.

(Refer to figure 19)

1. Master unit (*)
2. Sub unit (*)
3. Outside unit A
4. Outside unit B
5. EL. COMPO. BOX (1)
6. (Only RXYQ~PAYD)
EL. COMPO. BOX (2)
7. (Only RXYQ~PAYD)
Do not open the EL. COMPO. BOX (2) lid.
(There are no work when installation)
8. Never connect the power wire.
9. To outside unit of other system
10. Use duplex wires (No polarity)
11. Indoor unit

(*) : The Outside unit that connect the transmission wiring to BS unit is Master unit of the multi system.
And the other units are Sub unit. (In this figure, Outside unit A is the Master unit.)
Check operation in installation work, Onsite settings and so on are done by operating the PC-board (A1P) of Master unit.

NOTE

- Do not connect the power wiring to terminals for the transmission wiring. Doing so would destroy the entire system.
- When connecting wires to the terminal block on the PC-board, too much heat or tightening could damage the PC-board. Attach with care. See the table below for the tightening torque of the transmission wiring terminals.

Screw size	Tightening torque (ft · lbf)
M3.5 (A1P)	0.59 ~ 0.71

- Transmission wiring (About the symbol ① ~ ②, see figure 19) should be done within the following limitations. If they are exceeded, transmission problems may occur.

① Between outside unit and indoor unit

Between outside unit and outside unit of other systems

- Max. wiring length : 3280 ft
- Max. total wiring length : 6560 ft
- Max. no. of branches : 16

[Note]

No branch is allowed after branch (See figure 20)

Max. no. of outside units of other system that can be connected : 10

(Refer to figure 20)

1. Branch
2. Branch after branch

② Between outside unit and outside unit of same system

Max. wiring length : 100 ft

- The transmission wiring inside the EL.COMPO.BOX should be secured using the clamp (1) as shown in figure 21.

(Refer to figure 21)

1. In the EL.COMPO.BOX
2. Retain to the EL.COMPO.BOX with the accessory clamp (1).
3. Vinyl tube (accessory)

- Outside the units, the transmission wiring must be finished simultaneously with the local refrigerant piping, and wound with tape (field supply) as shown in figure 22.

(Refer to figure 22)

1. Liquid pipe
2. Gas pipe
3. Transmission wiring
4. Insulation material
5. Finishing tape

- For multi system:

1. Transmission wiring between outside units in the same piping system must be connected to terminals Q1 and Q2 (TO MULTI UNIT). Connecting the wires to the F1, F2 (TO OUT/D UNIT) terminals results in system malfunction.
2. Wiring to other systems should be connected to terminals F1 and F2 (TO OUT/D UNIT) on the PC-board of the master unit. The outside unit that connected transmission wiring to indoor unit is the master unit. The others are sub unit.

7-5 Power Wiring Connection Procedure

- Be sure to connect the power supply wiring to the power supply terminal block and hold it in place using the included clamp as shown in the figure 23.
- The L1, L2, L3 and N phases of the power wiring should be secured separately to the hook using the included clamp (1).
- The ground wiring should be bound to the power wiring using the included clamp (1) to prevent outside force from being applied to the terminal area.

(Refer to figure 23)

1. Power supply
(MODEL PAYD : 3 ~ 460V 60Hz)
(MODEL PATJ : 3 ~ 208-230V 60Hz)
2. Earth leakage circuit breaker
3. Branch switch, earth leakage circuit breaker
4. Ground wire
5. EL. COMPO. BOX (1)
6. (Only RXYQ~PAYD)
EL. COMPO. BOX (2)
7. (Only RXYQ~PAYD)
Do not open the EL. COMPO. BOX (2) lid.
(There are no work when installation.)
8. Attach insulation sleeves
9. Power supply terminal block
10. Ground terminal
11. Clamp (1) (accessory)
12. Vinyl tube (accessory)

CAUTION

- Be sure to use crimp-style terminal with insulating sleeves for connections. (See the figure below.)

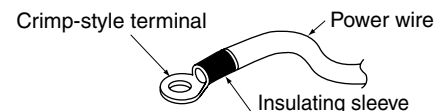

- For wiring, use the designated power wire and connect firmly, then secure to prevent outside pressure being exerted on the terminal board.
- Use an appropriate screwdriver for tightening the terminal screws. A screwdriver with a small head will strip the head and make proper tightening impossible.
- Over-tightening the terminal screws may break them. See the following table for the tightening torque of the terminal screws.

Screw size	Tightening torque (ft · lbf)
M8 Power terminal, ground terminal	4.06 ~ 5.38

- When pulling the ground wire out, wire it so that it comes through the cut out section of the cup washer. (See the figure below.) An improper ground connection may prevent a good ground from being achieved.

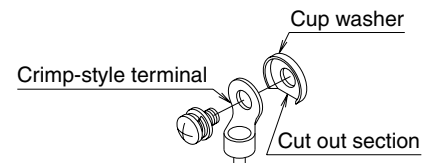

- When two wires are connected to a single terminal, connect them so that the rear sides of the crimp contacts face each other. Also, make sure the thinner wire is on top, securing the two wires simultaneously to the resin hook using the included clamp (1).

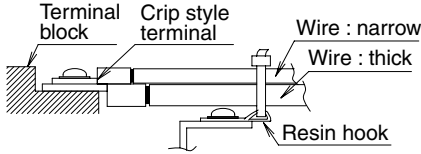

7-6 Procedure for Wiring Inside Units

- Referring to figure 24, secure and wire the power and transmission wiring using the included clamp (1), (2), and (3).
- Wire so that the ground wiring does not come into contact with the compressor lead wiring. If they touch, this may have an adverse effect on other devices.
- The transmission wiring must be at least 2 in. away from the power wiring.
- Make sure all wiring do not contact to the pipes (hatching parts in the figure 24).

(Refer to figure 24)

- Retain with accessory clamp (3).
- Electric conduit
- When routing out the power/ground wires from the left side.
- When routing out the transmission wiring from the opening for piping.
- When routing out the power/ground wires from the front.
- Clear over 2 in..
- When routing out the transmission wiring from the knockout hole.
- Retain to the back of the column support with the accessory clamp (2).
- When routing out the power/ground wires from the right side.
- Power wiring
- Transmission wiring
- Ground wire

Precautions when knocking out knockout holes

- To punch out a knockout hole, hit it with a hammer.
- Open an appropriate hole as needed.
- After knocking out the holes, trim off the burr, then we recommend you to paint the edges and areas around the edges using the repair paint to prevent rusting.
- Power line : Open a knockout hole as shown at left and connect it using a conduit.
- Transmission line : Connect it using a conduit in the knockout hole on the right.

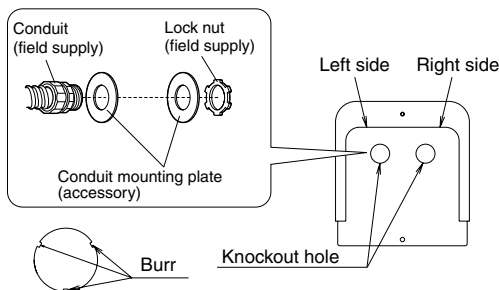

NOTE

- After wiring work is completed, check to make sure there are no loose connections among the electrical parts in the EL.COMPO.BOX.

8. AIR TIGHT TEST AND VACUUM DRYING

- After finished piping work, carry out air tight test and vacuum drying.

NOTE

- Always use nitrogen gas for the airtightness test.
- Absolutely do not open the shutoff valve until the main power circuit insulation measurement has been completed. (measuring after the shutoff valve is opened will cause the insulation value to drop.)

<Needed tools>

Gauge manifold Charge hose valve	<ul style="list-style-type: none"> To prevent entry of any impurities and insure sufficient pressure resistance, always use the special tools dedicated for R410A. Use charge hose that have pushing stick for connecting to service port of shutoff valves or refrigerant charge port.
Vacuum pump	<ul style="list-style-type: none"> The vacuum pump for vacuum drying should be able to lower the pressure to -14.6 psi. Take care the pump oil never flow backward into the refrigerant pipe during the pump stops.

<The system for air tight test and vacuum drying>

- Referring to figure 25, connect a nitrogen tank, refrigerant tank, and a vacuum pump to the outside unit.

The refrigerant tank and the charge hose connection to refrigerant charge port or the valve A in figure 25 are needed in "11. ADDITIONAL REFRIGERANT CHARGE AND CHECK OPERATION".

(Refer to figure 25)

- Gauge manifold
- Nitrogen
- Measuring device
- R410A tank (with siphon)
- Vacuum pump
- Charge hose
- High side equalizer pipe shutoff valve
- Gas pipe shutoff valve
- Low side equalizer pipe shutoff valve
- Liquid pipe shutoff valve
- Refrigerant charge port
- Valve A
- Valve B
- Valve C
- Outside unit
- Indoor unit
- Shutoff valve
- Service port
- Field piping
- Gas flow

NOTE

- The air-tightness test and vacuum drying should be done using the service ports of equalizer pipe, gas pipe and liquid pipe shutoff valve.

See the [R410A] Label attached to the front plate of the outside unit for details on the location of the service port (see figure at right)

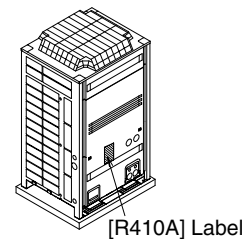

- See [Shutoff valve operation procedure] in "11-1 Before working" for details on handling the shutoff valve.
- The refrigerant charge port is connected to unit pipe. When shipped, the unit contains the refrigerant, so use caution when attaching the charge hose.

<Air tight test>

Pressurize the liquid pipe, gas pipe, and equalizer pipe from the service ports of each shutoff valve to 550 psi (do not pressurize more than 550 psi). If the pressure does not drop within 24 hours, the system passes the test.

If there is a pressure drop, check for leaks, make repairs and perform the airtight test again.

<Vacuum drying>

Evacuate the system from the liquid pipe, gas pipe, and equalizer pipe shutoff valve service ports by using a vacuum pump for more than 2 hours and bring the system to -14.6 psi or less. After keeping the system under that condition for more than 1 hour, check if the vacuum gauge rises or not. If it rises, the system may either contain moisture inside or have leaks.

NOTE

If moisture might enter the piping, follow belows. (I.e., if doing work during the rainy season, if the actual work takes long enough that condensation may form on the inside of the pipes, if rain might enter the pipes during work, etc.)

After evacuating the system for 2 hours, pressurize the system to 7.25 psi (vacuum break) with nitrogen gas and evacuate the system again using the vacuum pump for 1 hour to -14.6 psi or less (vacuum drying). If the system cannot be evacuated to -14.6 psi within 2 hours, repeat the operation of vacuum break and vacuum drying. Then, after leaving the system in vacuum for 1 hour, confirm that the vacuum gauge does not rise.



9. PIPE INSULATION

- Insulation of pipes should be done after performing "8. AIR TIGHT TEST AND VACUUM DRYING".
- Always insulate the liquid piping, the gas piping, the equalizer pipe (between the outside units for the outdoor multi system) and these pipe connections.
Failing to insulate the pipes may cause leaking or burns.
And be sure to use the insulation which can withstand such temperatures of 248°F or more for the equalizer pipe and the gas piping.
- Reinforce the insulation on the refrigerant piping according to the installation environment. Condensation might form on the surface of the insulation. Refer to the below.
 - Ambient temperature : 86°F, humidity : 75% to 80% RH : min. thickness : 9/16 in..
 - If the ambient temperature exceeds 86°F and the humidity 80% RH, then the min. thickness is 3/4 in..
See the Engineering data book for detail.
- If there is a possibility that condensation on the shutoff valve might drip down into the indoor unit through gaps in the insulation and piping because the outside unit is located higher than the indoor unit, etc., this must be prevented by caulking the connections, etc. (Refer to figure 26)
- The piping lead-out hole lid should be attached after opening a knock hole. (Refer to figure 27)
- If small animals and the like might enter the unit through the piping lead-out hole, close the hole with blocking material (procured on site) after completion of "11. ADDITIONAL REFRIGERANT CHARGE AND CHECK OPERATION". (Refer to figure 30)

(Refer to figure 26)

- Insulation material
- Caulking, etc.

(Refer to figure 27)

- Piping lead-out hole lid
- Open a knock hole at " ".
- Block " ".

NOTE

- After knocking out the holes, we recommend you remove burrs in the knock holes (See figure 27) and paint the edges and areas around the edges using the repair paint.

10. CHECKING OF DEVICE AND INSTALLATION CONDITIONS

Be sure to check the followings.

For those doing electrical work

- Make sure there is no faulty transmission wiring or loosening of a nut. See "7-4 Transmission Wiring Connection Procedure".
- Make sure there is no faulty power wiring or loosening of a nut. See "7-5 Power Wiring Connection Procedure".
- Has the insulation of the main power circuit deteriorated? Measure the insulation and check the insulation is above regular value in accordance with relevant local and national regulations.

For those doing pipe work

- Make sure piping size is correct. See "6-1 Selection of piping material and Refrigerant branching kit".
- Make sure insulation work is done. See "9. PIPE INSULATION".
- Make sure there is no faulty refrigerant piping. See "6. REFRIGERANT PIPING".

11. ADDITIONAL REFRIGERANT CHARGE AND CHECK OPERATION



The outside unit is charged with refrigerant when shipped from the factory, but depending on the size and length of the piping when installed, it may require additional charging.

For charging the additional refrigerant, follow the procedure in this chapter. And then carry out the check operation.

11-1 Before working

[About the refrigerant tank]

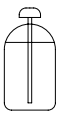
Check whether the tank has a siphon pipe before charging and place the tank so that the refrigerant is charged in liquid form. (See the figure below.)

With siphon pipe	
	Stand the tank upright and charge. (The siphon pipe goes all the way inside, so the tank does not need be put upside-down charge in liquid form.)
Other tanks	
	Stand the tank upside-down and charge.

NOTE

- Always use the proper refrigerant (R410A). If charged with the refrigerant containing an improper material, it may cause an explosion or accident.
- R410A is a mixed refrigerant, so charging it as a gas will cause the refrigerant composition to change, which may prevent normal operation.

[Shutoff valve operation procedure]

When operating the shutoff valve, follow the procedure instructed below.

NOTE

- Do not open the shutoff valve until "10. CHECKING OF DEVICE AND INSTALLATION CONDITIONS" are completed. If the shutoff valve is left open without turning on the power, it may cause refrigerant to buildup in the compressor, leading insulation degradation.
- Be sure to use the correct tools.
The shutoff valve is not a back-seat type. If forced it to open, it might break the valve body.
- When using a service port, use the charge hose.
- After tightening the cap, make sure no refrigerant gas is leaking.

Tightening torque

The sizes of the shutoff valves on each model and the tightening torque for each size are listed in the table below.

<Size of Shutoff Valve>

	72PA type	96PA type	108PA type
Liquid pipe shutoff valve	φ3/8 The 108PA type corresponds to the φ1/2 - diameter onsite piping using the accessory pipe.		
Low side equalizer pipe shutoff valve	φ1 All types corresponds to the φ3/4 - diameter onsite piping using the accessory pipe.		
Gas shutoff valve	φ3/4 The 72PA type corresponds to the φ3/4 - diameter onsite piping using the accessory pipe. The 96PA type corresponds to the φ7/8 - diameter onsite piping using the accessory pipe. The 108PA type corresponds to the φ1-1/8 - diameter onsite piping using the accessory pipe.		
High side equalizer pipe shutoff valve	φ3/4		

(Refer to figure 28)

1. Service port
2. Cap
3. Hex holes
4. Shaft (valve body)
5. Seal section

[How to Check How Many Units are Connected]

It is possible to find out how many indoor or outside unit in the system are turned on by operating the push button on the PC-board (A1P) of outside unit (In case of multi system master unit).

Follow the procedure below to check how many indoor or outside units are turned on.

(LED display: ● ...OFF ☀ ...ON ⚡ ...Blinking * ...Uncertain)	LED display						
	H1P	H2P	H3P	H4P	H5P	H6P	H7P
(1) Press the MODE button (BS1) once at Setting Mode 1 (H1P : off), and set the MONITOR MODE (H1P : Blinking).	⚡	●	●	●	●	●	●
(2) Press the SET button (BS2) the number of times until the LED display matches that at right.	For checking the number of outside units : eight times	⚡	●	●	☀	●	●
	For checking the number of indoor units : five times	⚡	●	●	●	☀	☀
(3) Press the RETURN button (BS3) and read the number of units from the display of H2P through H7P. [Reading Method] The display of H2P through H7P should be read as a binary number, with ⚡ standing for "1" and ● standing for "0".	⚡	*	*	*	*	*	*
Ex: For the LED display at right, this would be "0 1 0 1 1 0", which would mean 22 units are connected. $32 \times 0 + 16 \times 1 + 8 \times 0 + 4 \times 1 + 2 \times 1 + 1 \times 0 = 22 \text{ units}$ Note: "000000" indicates 64 units.	⚡	●	⚡	●	⚡	⚡	●
(4) Press the MODE button (BS1) once. This returns to Setting Mode 1 (H1P : OFF, default).	●	●	☀	●	●	●	●

NOTE
Press the "MODE button" (BS1) if you get confused while operating. This returns to **Setting Mode 1** (H1P : OFF, default).

11-2 Procedure of Adding Refrigerant charging and check operation

WARNING Electric Shock Warning

- Make sure to close the EL. COMPO. BOX lid before turning on the power.
- Perform the setting on the PC-board (A1P) of the outside unit and check the LED display after the power is on via the inspection door which is in the EL. COMPO. BOX lid.

To open

1. Remove the cap and turn the shaft counterclockwise with the hexagon wrench.
2. Turn it until the shaft stops.
3. Make sure to tighten the cap securely.
(For the tightening torque, refer to the item <Tightening Torque>.)

To close

1. Remove the cap and turn the shaft clockwise with the hexagon wrench.
2. Securely tighten the valve until the shaft contacts the main body seal.
3. Make sure to tighten the cap securely.
(For the tightening torque, refer to the item <Tightening Torque>.)

<Tightening torque>

Shutoff valve size	Tightening torque ft · lbf (Turn clockwise to close)			Service port
	Shaft (valve body)		Cap (valve lid)	
φ 3/8	3.98 - 4.87	Hexagonal wrench 4mm	9.95 - 12.17	8.48 - 10.3
φ 1/2	5.97 - 7.30		13.3 - 16.2	
φ 3/4	19.9 - 24.3	Hexagonal wrench 8mm	16.6 - 20.3	
φ 1				

(Refer to figure 29)

1. EL. COMPO. BOX (1)
2. Inspection door
3. EL. COMPO. BOX (1) lid
4. LED (H1~8P)
5. Push button(BS1~5)
6. Lift the protruding part to open the inspection door.

- Use an insulated rod to operate the push buttons via the EL. COMPO. BOX's inspection door.
There is a risk of electric shock if you touch any live parts, since this operation must be performed with the power on.

CAUTION

- Make sure to use the protect tool (protective grooves and goggles) when charging the refrigerant.
- Due to a danger of liquid hammer, the refrigerant must not be charged over the allowable maximum amount when charging the refrigerant.
- Do not perform the refrigerant charging operation under working for the indoor unit.
- When opening the front panel, make sure to take caution to the fan rotation during the working.
After the outside unit stops operating, the fan may keep rotation for a while.

NOTE

- If operation is performed within 12 minutes after the indoor and outside units are turned on, H2P will be lit on and the compressor will not operate.
Check the LED display indicate as shown below.

H1P	H2P	H3P	H4P	H5P	H6P	H7P
●	●	☀	●	●	●	●

- In order to ensure uniform refrigerant distribution, it may take up to around 10 minutes for the compressor to start up after the unit starting operating. This is not a malfunction.
- The refrigerant charge port is connected to the piping inside the unit. When the unit is shipped from the factory, the unit's internal piping is already charged with refrigerant, so be careful when connecting the charge hose.
- After adding the refrigerant, make sure to close the lid of the refrigerant charging port.
The tightening torque for the lid is 8.48 to 10.3 ft · lbf.
- See [Shutoff valve operation procedure] in chapter 11-1 for details on how to handle shutoff valves.
- When done or when pausing the refrigerant charging operation, close the valve of the refrigerant tank immediately.
The refrigerant charge port of this product have electric expansion valve. The valve will be closed at end of refrigerant charging. However the valve will be opened on operation after refrigerant charging (check operation, normal operation, etc.).
If the tank is left with the valve open, the amount of refrigerant which is properly charged may be off the point.
- Make sure to perform the check operation after installation. Otherwise, the malfunction code "U3" will be displayed and normal operation cannot be performed.
And the failure of "Check of miswiring" may also cause abnormal operation. Performance may drop due to the failure of "Judgment of piping length".
- Check operation must be performed for each refrigerant piping system. Checking is impossible if plural systems are being done at once.
- The individual problems of indoor units can not be checked.
About these problems check by test run after the check operation is completed. (See chapter 13)
- The check operation cannot be performed in recovery or other service modes.

11-2-1 Procedure of Adding Refrigerant charging

1. Make sure the following works are complete in accordance with the installation manual.
 - Piping work
 - Wiring work
 - Air tight test
 - Vacuum drying
 - Installation work for indoor unit
2. Calculate the "additional charging amount" using "How to calculate the additional refrigerant to be charged" in "6-5 Example of connection".
3. Open the valve B (See the figure 30. The valve A,C and the liquid pipe, gas pipe, equalizer pipe shutoff valves must be left closed), and charge the refrigerant of the "additional charging amount" from the liquid side shutout valve service port.

(Refer to figure 30)

1. Measuring device
 2. R410A tank (with siphon)
 3. Charge hose
 4. High side equalizer pipe shutoff valve
 5. Gas pipe shutoff valve
 6. Low side equalizer pipe shutoff valve
 7. Liquid pipe shutoff valve
 8. Refrigerant charge port
 9. Valve A
 10. Valve B
 11. Valve C
 12. Outside unit A
 13. Outside unit B
 14. Indoor unit
 15. Field pipings
 16. Refrigerant flow
 17. Shutoff valve
 18. Service port
4. If the "additional charging amount" was charged fully, close the valve B and go to step 6.
If the "additional charging amount" was not charged fully, close the valve B and go to step 5.
 5. Perform the refrigerant charging following [Automatic refrigerant charging operation procedure] as shown below. And charge the remaining refrigerant of the "additional charging amount".

NOTE

- For performing the automatic refrigerant charging operation, the push button on the PC-board (A1) of outside unit are used. (See figure 29.) And the refrigerant are charged from the refrigerant charge port via the valve A. (See figure 31.) For operating the push button and opening or closing the valves, follow the procedure.
- During Automatic refrigerant charging operation, the system will select charging mode (cooling mode or heating mode) by the temperature condition as follows.

Outdoor temp. : 32°F DB ~ 109°F DB	} →	Cooling mode
Indoor temp. : 50°F DB ~ 90°F DB		
Less than above range	→	Heating mode

When charging in cooling mode, the system will stop operation when the required amount of refrigerant is charged.

During charging in heating mode, a person must manually close valve A and stop operation.

Beforehand, check the remaining refrigerant that is needed to charge based on the "additional charging amount" in step 2 and the charged amount in step 3.

- The refrigerant will be charged about 66 lb in one hour at outdoor temp. 86°F DB (about 26 lb at outdoor temp. 32°F DB).
- During Automatic refrigerant charging operation, you can stop the operation forcibly by pushing MODE button (BS1).

(Refer to figure 31)

1. Measuring device
2. R410A tank (with siphon)
3. Charge hose
4. High side equalizer pipe shutoff valve
5. Gas pipe shutoff valve
6. Low side equalizer pipe shutoff valve
7. Liquid pipe shutoff valve
8. Refrigerant charge port
9. Valve A
10. Valve B
11. Valve C
12. Outside unit A
13. Outside unit B
14. Indoor unit
15. Field pipings
16. Refrigerant flow when charging
17. Shutoff valve
18. Service port
19. The refrigerant will be charged about 66 lb in one hour at outdoor temp. 86°FDB (26 lb at 32°FDB). (According to outdoor temp. or the refrigerant amount in the tank, the charging rate may speed up). If you need to speed up in case of multi system, connect the refrigerant tanks to each outside unit.

[Automatic refrigerant charging operation procedure]

NOTE

- The marks of LED mean as follows.

- Open the liquid pipe and gas pipe shutoff valves. (The valve A-C must be closed. See figure 31.)
- Close the EL. COMPO. BOX (1) lid and all front panel except on the EL. COMPO. BOX (1) side. (*1) And turn the power to the outdoor unit and all connected indoor units. (*2)
 - After H2P stop blinking (about 12 minutes after turning on the power), check H2P is OFF.
 - If H2P is ON, check the malfunction code in the remote controller of indoor unit and correct the malfunction in accordance with [Remote controller display malfunction code] in chapter 11-2-2.
- Check the LED. And push the MODE button (BS1) once if the LED displays is not as below.

H1P	H2P	H3P	H4P	H5P	H6P	H7P
●	●	⊙	●	●	●	●

- Push the TEST button (BS4) once. (The LED displays will change as below.)

H1P	H2P	H3P	H4P	H5P	H6P	H7P
⊙	⊙	⊙	⊙	⊙	⊙	⊙

- Hold the TEST button (BS4) down for 5 seconds or more. (The LED displays will change as below and fan of outside unit will start rotation.)

H1P	H2P	H3P	H4P	H5P	H6P	H7P
●	⊙	●	●	●	*	*

- When the compressor start working and the LED displays change any state in below (*3), go to "In case of cooling mode" or "In case of heating mode" in accordance with the LED displays.

H1P	H2P	H3P	H4P	H5P	H6P	H7P
⊙	⊙	⊙	●	⊙	●	⊙
⊙	⊙	●	●	⊙	●	⊙

→ Go to "In case of cooling mode"
 → Go to "In case of heating mode"

In case of cooling mode

- Push the TEST button (BS4) once within 5 minutes after procedure (5) (*4) and close the all front panels (*5). After that, open the valve A immediately (See figure 31) (*6) and watch the remote controller display of indoor unit.
- If the remote controller display shows "PE" code (*7), ready to close the valve A. And go to procedure (9).
 If the remote controller display shows other code, close the valve A immediately and refer to [Remote controller cooling mode malfunction code]

⚠ Beware the fan running when open the front panel. The fan may continue rotation after the system stop the operation.

- When the compressor stop working (the fan may continue rotation.), close the valve A immediately (*8). And check the LED displays are as below and the remote controller display shows "P9" code.

H1P	H2P	H3P	H4P	H5P	H6P	H7P
⊙	⊙	⊙	⊙	⊙	⊙	⊙

After checking, push the MODE button (BS1) once and the charging is complete.

In case of heating mode

- Push the TEST button (BS4) once within 5 minutes after procedure (5) (*4) and close the all front panels. After that, open the valve A immediately (See figure 31) (*6) and check the charged amount by measuring device. During operation, if the remote controller display shows "P2" or "P8" code, close the valve A immediately and refer to [Remote controller heating mode malfunction code].

⚠ Beware the fan running when open the front panel. The fan may continue rotation after the system stop the operation.

- When the required amount of refrigerant is charged, close the valve A (See figure 30) (*8) and push the RETURN button (BS3) once. And then go to procedure (9).
- Push the MODE button (BS1) once, and the charging is complete.

Notes (*1)~(*9)

- (*1) Lead the refrigerant charge hose etc from the pipe intake. All front panels must be closed at the procedure (7).
- (*2) If you perform the refrigerant charging operation within the refrigerant system that have the power off unit, the operation cannot finish properly. Check the number of outside and indoor units that is powered. For checking, see [How to check how many units are connected] in chapter 11-1.
 - To energize the crankcase heater, make sure to turn on for 6 hours before starting operation.
- (*3) It takes about 2~10 minutes for getting stability of refrigerant state. If the additional refrigerant is little and operation is started before getting stability, the system can not judge the charging amount precisely and it cause over charge.
- (*4) If the TEST button (BS4) is not pushed within 5 minutes, "P2" code will displayed in the remote controller. In this case, refer [Remote controller cooling (or heating) mode malfunction code].
- (*5) If the front panel is opened during the operation, the system cannot operate properly.
- (*6) If you leave the system without connecting the refrigerant tank or opening the valve A for 30 minutes or more, the system stop operation and "P2" code are displayed in remote controller. In this case, refer [Remote controller cooling (or heating) mode malfunction code].
- (*7) Depending on the situation of operation such as the charging amount is little, the "PE" code may not be displayed and the "P9" code may be displayed.
- (*8) Always close the valve A and take the tank off. The refrigerant charge port of this unit have electric expansion valve and the valve are closed when charging is finished. However, the valve will opened when ather operation (Check operation, normal operation, etc.). If you leave the tank connected, the refrigerant will charged and it cause over charge.

[Remote controller cooling mode malfunction code]

Code	The work contents	
PE	Charging is almost finished. Ready to close the valve A.	
PA PH	The refrigerant tank is empty. Close the valve A and replace empty tank to the new tank. After changing the tank, open the valve A again. ⚠ Beware the fan running. The outside unit does not stop operation.	
P8	Close the valve A immediately, and restart the operation from procedure (3).	
P2	Operation is interrupted. Close the valve A immediately and check the below items. <ul style="list-style-type: none"> Check if gas pipe or liquid pipe shutoff valve is opened. Check the refrigerant tank is connected and the valve A was opened. Check if the air inlet and outlet of the indoor unit are not closed by an obstruction. 	After correcting the abnormality, restart the operation from procedure (3).
*	Operation is stopped abnormally. Close the valve A immediately. Confirm the malfunction code and correct the abnormality following the [Remote controller displays malfunction code] in chapter 11-2-2.	
P9	Charging is finished. Close the valve A and take the refrigerant tank off.	

[Remote controller heating mode malfunction code]

Code	The work contents	
P8	Close the valve A immediately and push the TEST button (BS4) once. And restart from procedure (7) of "In case of heating mode".	
P2	Operation is interrupted. Close the valve A immediately and check the below items. <ul style="list-style-type: none"> Check if gas pipe or liquid pipe shutoff valve is opened. Check the refrigerant tank is connected and the valve A was opened. Check if the air inlet and outlet of the indoor unit are not closed by an obstruction. 	

6. After completing the additional refrigerant charging, record the charging amount on the accessory "REQUEST FOR THE INDICATION" label (Installation records) and adhere it to the back side of the front panel.

11-2-2 Procedure of check operation

- Check operation perform the following work. Do the check operation following below.
Otherwise, malfunction code "U3" will be displayed in the remote controller and normal operation can not be carried out.
 - Check of shutoff valve opening
 - Check of miswiring
 - Judgment of piping length
 - Check of refrigerant overcharge

NOTE

- Check operation can not be carried out at outdoor temp. less than 23°F. Perform the check operation at day or time that outdoor temp. is 23°F or more.

[Check Operation Procedure]

- Close the EL. COMPO. BOX lid and all front panels except as the side of the EL. COMPO. BOX and turn on the power to the outside unit and all connected indoor units. (Be sure to turn the power on at least 6 hours before operation in order to have power running to the crank case heater.)
- Make the onsite settings as needed using the push button (BS1-BS5) on the outside unit PC-board (A1P) with the power on. (See "12 Onsite Settings")
- Perform the check operation following the Check Operation Method of the [Service Precautions] label (lower) on the EL. COMPO. BOX lid. (See figure 32) The system operation for about 40~60 minutes and automatically stops the check operation.
If the malfunction code is not displayed in the remote controller after the system stop, check operation is completed. Normal operation will be possible after 5 minutes. If the malfunction code is displayed in the remote controller, correct the malfunction following [Remote controller displays malfunction code] and perform the check operation again.

(Refer to figure 32)

- EL. COMPO. BOX (1) lid
- (Only RXYQ~PAYD
EL. COMPO. BOX (2) lid
- [Service Precaution] label (upper)
- [Service Precaution] label (lower)

NOTE

For interrupting the check operation, push RETURN button (BS3).

[Remote controller displays malfunction code]

Malfunction code	Installation error	Remedial action
E3, E4 F3, F6 UF	The shutoff valve of the outside unit is left closed.	Open the shutoff valve.
U1	The phases of the power to the outside unit is reversed.	Exchange two of the three phases (L1, L2, L3) to make a proper connection.
U1 U4 LC	No power is supplied to an outside or indoor unit (including phase interruption).	Make sure the power source wire is properly connected to the outside or indoor unit and revise if necessary.
UF	There is conflict on the connection of transmission wiring in the system.	Check if the refrigerant piping line and the transmission wiring are consistent with each other.
E3 F6 UF	Refrigerant overcharge.	Recalculate the additional amount refrigerant from the piping length and correct the refrigerant charge level by recovering any excessive refrigerant with a refrigerant recovery machine.
E4 F3	Insufficient refrigerant.	<ul style="list-style-type: none"> Check if the additional refrigerant charge has been finished correctly. Recalculate the additional amount refrigerant from the piping length and add the adequate amount.

U7, U4 UF, UH	Field wiring is connected to "TO MULTI UNIT (Q1,Q2)" terminal on the outside unit PC-board (A1P) when the system is one outdoor system.	Remove the line from the "TO MULTI UNIT (Q1, Q2)" terminal.
------------------	---	---

NOTE

If any malfunction codes other than the above are displayed, check the service manual for how to respond.

12. ONSITE SETTINGS

NOTE

In the case of a multi system, all onsite settings should be made on the master unit. Settings made on sub units are invalid. The outside unit to which the indoor unit transmission wire are connected is the master unit, and all other units are sub units.

Use the push button switches (BS1 through BS5) on the outside unit PC-board (A1P) to make the necessary onsite settings. See the "Service Precautions" label (upper) on the EL. CONPO. BOX lid for details on the positions and operating method of the push button switches and on the onsite setting. Make sure to record the setting on the accessory "REQUEST FOR THE INDICATION" label.

WARNING Electric Shock Warning

Use an insulated rod to operate the push buttons via the inspection door of EL. COMPO. BOX lid. There is a risk of electric shock if you touch any live parts, since this operation must be performed with the power on.

13. TEST RUN

13-1 Before test run

- Make sure the following works are completed in accordance with the installation manual.
 - Piping work
 - Wiring work
 - Air tight test
 - Vacuum drying
 - Additional refrigerant charge
 - Check operation
- Check that all work for the indoor unit are finished and there are no danger to operate.

13-2 Test Run

After all works are completed, operate the unit normally and check the following.

- Make sure the indoor and outside units are operating normally.
- Operate each indoor unit one by one and make sure the corresponding outside unit is also operating.
- Check to see if cold (or hot) air is coming out from the indoor unit.
- Push the fan direction and strength buttons on the remote controller to see if they operate properly.

NOTE

- Heating is not possible if the outdoor temperature is 75°F or higher. Refer to the Operation manual.
- If a knocking sound can be heard in the liquid compression of the compressor, stop the unit immediately and then energize the crank case heater for a sufficient length of time before restarting the operation.
- Once stopping, the compressor will not restart in about 5 minutes even if the On/Off button of the remote controller is pushed.
- When the system operation is stopped by the remote controller, the outside units may continue operating for further 5 minutes at maximum.
- The outside unit fan may rotate at low speeds if the Night-time low noise setting or the External low noise level setting is made, but this is not a malfunction.
- If the check operation was not performed at first installation, the malfunction code "U3" will be displayed in the remote controller. Perform the check operation following "11-2-2 Procedure of Check Operation".

13-3 Checks After Test Run

Perform the following checks after the test run is complete.

- Record the contents of field setting.
 - Record them on the accessory "REQUEST FOR THE INDICATION" label.
 - And attach the label on the back side of the front panel.
- Record the installation date.
 - Record the installation date on the accessory "REQUEST FOR THE INDICATION" label in accordance with the IEC60335-2-40.
 - And attach the label on the back side of the front panel.

NOTE

After the test run, when handing the unit over to the customer, make sure the EL.COMPO.BOX lid, the inspection door, and the unit casing are all attached.

14. CAUTION FOR REFRIGERANT LEAKS

(Points to note in connection with refrigerant leaks)

Introduction

The installer and system specialist shall secure safety against leakage according to local regulations or standards. The following standards may be applicable if local regulations are not available.

The VRV System, like other air conditioning systems, uses R410A as refrigerant. R410A itself is an entirely safe non-toxic, non-combustible refrigerant. Nevertheless care must be taken to ensure that air conditioning facilities are installed in a room which is sufficiently large. This assures that the maximum concentration level of refrigerant gas is not exceeded, in the unlikely event of major leak in the system and this in accordance to the local applicable regulations and standards.

Maximum concentration level

The maximum charge of refrigerant and the calculation of the maximum concentration of refrigerant is directly related to the humanly occupied space in to which it could leak.

The unit of measurement of the concentration is lb/ft³ (the weight in lb of the refrigerant gas in 1 ft³ volume of the occupied space).

Compliance to the local applicable regulations and standards for the maximum allowable concentration level is required.

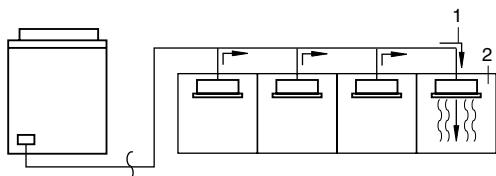

- direction of the refrigerant flow
- room where refrigerant leak has occurred (outflow of all the refrigerant from the system)

Pay a special attention to the place, such as a basement, etc. where refrigerant can stay, since refrigerant is heavier than air.

Procedure for checking maximum concentration

Check the maximum concentration level in accordance with steps 1 to 4 below and take whatever action is necessary to comply.

- Calculate the amount of refrigerant (lb) charged to each system separately.

amount of refrigerant in a single unit system (amount of refrigerant with which the system is charged before leaving the factory)	+	additional charging amount (amount of refrigerant added locally in accordance with the length or diameter of the refrigerant piping)	=	total amount of refrigerant (lb) in the system
---	---	--	---	--

NOTE

- Where a single refrigerant facility is divided into 2 entirely independent refrigerant systems then use the amount of refrigerant with which each separate system is charged.

- Calculate the smallest room volume (ft³)
Incase like the following, calculate the volume of (A), (B) as a single room or as the smallest room.

A. Where there are no smaller room divisions

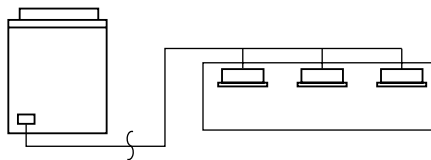

B. Where there is a room division but there is an opening between the rooms sufficiently large to permit a free flow of air back and forth.

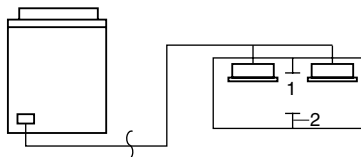

- opening between rooms
- partition

(Where there is an opening without a door or where there are openings above and below the door which are each equivalent in size to 0.15% or more of the floor area.)

- Calculating the refrigerant density using the results of the calculations in steps 1 and 2 above.

$$\frac{\text{total volume of refrigerant in the refrigerant system}}{\text{size (ft}^3\text{) of smallest room in which there is an indoor unit installed}} \leq \text{maximum concentration level (lb/ft}^3\text{)}$$

If the result of the above calculation exceeds the maximum concentration level then make similar calculations for the second then third smallest room and so until the result falls short of the maximum concentration.

- Dealing with the situations where the result exceeds the maximum concentration level.
Where the installation of a facility results in a concentration in excess of the maximum concentration level then it will be necessary to revise the system. Please consult your Daikin supplier.

DAIKIN AC (AMERICAS), INC.

1645 Wallace Drive, Suite 110
Carrollton, TX 75006

info@daikinac.com
www.daikinac.com

DAIKIN INDUSTRIES, LTD.

Head office:

Umeda Center Bldg., 2-4-12, Nakazaki-Nishi,
Kita-ku, Osaka, 530-8323 Japan

Tokyo office:

JR Shinagawa East Bldg., 2-18-1, Konan,
Minato-ku, Tokyo, 108-0075 Japan

